

Fixed Coaxial Attenuators



- /// dc to 52 GHz, up to 1,000 Watts
- /// Choice of frequency ranges, attenuation value and power level.
- /// Consistent, repeatable performance
- /// High reliability
- /// Rugged injection molded connectors
- /// Low Intermodulation (LIM) versions available
- /// Custom connector options

General Information

In this section of the catalog, each Fixed Coaxial Attenuator is outlined utilizing individual data sheets containing product features, specifications, and outline drawings. These data sheets are preceded by a quick reference guide to help you select the Fixed Coaxial Attenuator(s) that fits your needs. The page number for each Fixed Coaxial Attenuator data sheet is given in the quick reference guide.

From the company's very first DC - 1 GHz tee attenuator, came the technology that enabled the design of the first DC - 5 GHz, the first DC - 10 GHz, and the first DC - 18 GHz coaxial attenuators. These designs led to the development of the distributed resistor card attenuator element, which is the basis for most all attenuators manufactured today from DC - 60 GHz. Until the original patents expired a few years ago, most major attenuator manufacturers in the U.S. were licensed under one or more Weinschel Engineering, Co., patents.

















Also MIL-DTL-3933 Qualified - Aeroflex / Weinschel is a QPL supplier of Fixed Attenuators. Most Aeroflex / Weinschel Fixed Coaxial Attenuators can be supplied according to customer specified testing, environmental or military or government specification requirements (page 26).

Attenuator Sets of Aeroflex / Weinschel Fixed Attenuators are also available...see page 62.

NOTE: *EXPRESS* Shipment available via www.argosysales.com or 800-542-4457. Check with our distributor for current products and stocking quantities.



Fixed Attenuators...dc-42 GHz, 1-10 Watts













Model Number	Frequency Range (GHz)	Average Power (Watts)	Peak Power (kW)	Nominal Attenuation Value (dB)	SWR	Connector Type	Page No	
★ 1 ★ 2	dc-12.4 dc-18.0	5	1	1-10, 20, 30, 40, 50, 60	1.15-1.25* 1.15-1.35*	N	32	
★ 1W	dc-4.0	2	0.25	1-10, 20	1.25	N	30	
★ 3T ★ 4T	dc-12.4 dc-18.0	2	0.50	1-12, 20, 30, 40, 50, 60 1.15-1.35*	1.15-1.25*	SMA	22	
★ 3M ★ 4M	dc-12.4 dc-18.0	2	0.50	1-10, 20, 30, 40, 50, 60 1.15-1.35*	1.15-1.25*	SMA	21	
★ 4H	dc-18.6	2	0.25	0-10, 12, 15, 20, 30	1.15-1.35*	SMA	20	
★ 23 ★ 37	dc-18.0 dc-8.5	10 10	1 1	3, 6, 10, 20, 30, 40, 50, 60 3, 6, 10, 20, 30	1.15-1.35* 1.15-1.25*	N N	38 37	
32	dc-18.0	2	0.50	0-20 in 0.5 dB Increments	1.15-1.35*	SMA	23	
32J 87	dc-32.0	2	0.50	0-30 in 0.5 dB Increments	1.25	2.92mm	24 25	
★ 41	dc-18.0	10	1	1, 2, 3, 6, 10, 20, 30	1.20-1.35*	SMA	36	
★ 44	dc-18.0	5	1	1-10, 20, 30, 40, 50, 60	1.15-1.25*	N	33	
★ 54A	dc-42.0	2	0.5	3, 6, 10, 20, 30	1.25-1.40*	2.92mm	28	
★ 55	dc-18.0	5	1	3, 6, 10, 20, 30	1.15-1.35*	TNC	30	
★ 56	dc-28.0	2	0.5	0-10, 20, 30	1.10-1.25*	3.5mm	27	
★ 69A	dc-18.0	5	0.5	1-10, 20, 30	1.15-1.35*	SMA	34	
75A	dc-42.0	5	0.2	3, 6, 10, 20, 30	1.20-1.35*	2.92mm	35	
★ 84A	dc-40.0	2	0.5	3, 6, 10, 20, 30	1.35-1.50*	2.4mm	29	
★ 3330A ★ 3331A	dc-18.0	2	0.25	1-10, 20, 30	1.15-1.40*	SMA	19	

* VARIES WITH FREQUENCY.

★ EXPRESS Shipment available via www.aeroflex.com or 800-542-4457.
Note: Other models may also be available from Express delivery.

Fixed Coaxial Attenuators

Fixed Attenuators...dc-40 GHz, 20-100 Watts









Model Number	Frequency Range (GHz)	Average Power (Watts)	Peak Power (kW)	Nominal Attenuation Value (dB)	SWR	Connector Type	Page No	
★ 24	dc-8.5	50	5	3, 6, 10, 20, 30	1.20-1.30*	2.92mm/N	45	
★ 33	dc-8.5	25	5	3, 6, 10, 20, 30	1.20-1.30*	2.92mm/N	41	
★ 34	dc-4.0	25	5	3, 6, 10, 20, 30	1.10-1.20*		40	
★ 46	dc-18.0	25	1	3, 6, 10, 20, 30, 40	1.20-1.35*	3.5mm/N	42	
★ 47	dc-18.0	50	1	3, 6, 10, 20, 30, 40	1.20-1.45*	3.5mm/N	47	
★ 48	dc-18.0	100	1	6, 10, 20, 30, 40	1.25-1.55*	3.5mm/N	51	
★ 59	dc-2.5	100	10	10, 20, 30, 40	1.15	N	49	
★ 68	dc-4.0	100	10	1, 2, 3, 6, 10, 20, 30, 40	1.20	N	50	
★ 72	dc-4.0	50	5	3, 6, 10, 20, 30, 40	1.20	N/2.92mm	44	
★ 73	dc-8.5	100	5	3, 6, 10, 20, 30, 40	1.25-1.35*	N	52	
★ 74	dc-28	25	0.5	3, 6, 10, 20, 30	1.30-1.35*	3.5mm	43	
86	dc-22.0	50	1	3, 6, 10, 20, 30	1.30	3.5mm	48	
89	dc-40.0	20	0.2	10, 20, 30	1.25-1.40*	2.92mm	39	
90	dc-18.0	50	1	3, 6, 10, 20, 30	1.15-1.30	N	46	

* VARIES WITH FREQUENCY.

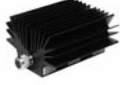
★ EXPRESS Shipment available via www.argosysales.com or 800-542-4457.

Note: Other models may also be available from Express delivery.

Fixed Attenuators...dc-18.0 GHz, 150-1000 Watts









Model Number	Frequency Range (GHz)	Average Power (Watts)	Peak Power (kW)	Nominal Attenuation Value (dB)	SWR	Connector Type	Page No.	
★ 40 ★ 57	dc-1.5 dc-5.0	150 150	10 10	3, 6, 10, 20, 30, 40 6, 10, 20, 30, 40	1.10 1.20	N N	53	
★ 45 ★ 58	dc-1.5 dc-5.0	250 250	10 10	3, 6, 10, 20, 30, 40 6, 10, 20, 30, 40	1.10 1.15-1.20*	N	57	
★ 49	dc-8.5	150	5	3, 6, 10, 20, 30, 40	1.25-1.35*	N	55	
★ 53	dc-2.5	500	10	3, 6, 10, 20, 30, 40	1.10	N	59	
65	dc-2.5	150	10	3, 6, 10, 20, 30	1.20	N	54	
66	dc-18.0	150	1	10, 20, 30, 40	1.90	N	56	
67	dc-12.7	350	5	10, 20, 30	1.30-1.60*	N	58	
81 <i>NEW</i>	dc-10.0	500	5	10, 20, 30, 40	1.65-1.90*	N	60	
★ 82	dc-3.0	1,000	10	10, 20, 30, 40	1.15-1.25*	N	61	

* VARIES WITH FREQUENCY.

★ EXPRESS Shipment available via www.argosysales.com or 800-542-4457.
Note: Other models may also be available from Express delivery.

Fixed Coaxial Attenuators

Low IM Fixed Attenuators...dc-18.0 GHz, 25-500 Watts

Model Number	Frequency Range (GHz)	Average Power (Watts)	Peak Power (kW)	Nominal Attenuation Value (dB)	SWR	Connector Type	Page No.	
24-XX-XX-LIM	dc-8.5	50	5	10, 20, 30	1.20-1.30*	2.92mm/N	45	
33-XX-XX-LIM	dc-8.5	25	5	10, 20, 30, 40	1.20-1.30*	2.92mm/N	41	
46-XX-XX-LIM	dc-18.0	25	1	10, 20, 30, 40	1.20-1.35*	3.5mm/N	42	
47-XX-XX-LIM	dc-18.0	50	1	10, 20, 30, 40	1.20-1.45*	3.5mm/N	47	
48-XX-XX-LIM	dc-18.0	100	1	10, 20, 30, 40	1.25-1.55*	3.5mm/N	51	
57-XX-XX-LIM	dc-5.0	150	10	10, 20, 30, 40	1.20	N	53	
58-XX-XX-LIM	dc-5.0	250	10	10, 20, 30, 40	1.20-1.25*	N	57	
49-XX-XX-LIM	dc-8.5	150	5	10, 20, 30, 40	1.25-1.35*	N	55	
53-XX-XX-LIM	dc-2.5	500	10	10, 20, 30, 40	1.10	N	59	

* VARIES WITH FREQUENCY.

Frequently Asked Questions about Fixed Coaxial Attenuators....

What are the advantages of Weinschel's fixed attenuators?

Aeroflex / Weinschel low power fixed attenuators feature a combination of advantages over other designs:*

1. Most Aeroflex / Weinschel attenuators feature injection molded dielectric for better center pin captivation and alignment. Injection molded dielectric also eliminates the need for the epoxy hole "stake" as seen in other designs. This epoxy hole in other designs is subject to RF leakage and movement when exposed to environmental extremes and prolonged use.
2. Aeroflex / Weinschel fixed attenuators have a proprietary resistor element, fired at 950°C for superior long term stability over temperature, power and time. The attenuator element is trimmed for precise custom attenuation values.
3. Aeroflex / Weinschel fixed attenuators have no solder contacts. They feature spring loaded plunger contacts to the resistor cards that provide expansion tolerance over wide temperature and power ranges.
4. Aeroflex / Weinschel fixed attenuators are made with high quality materials and machined to very close tolerances. The result is a design that stands up to severe environmental and multiple matings.
5. High power designs feature special high temperature dielectric support beads.

Does Aeroflex / Weinschel offer high reliability fixed attenuators?



Yes. Aeroflex / Weinschel is a major QPL supplier of **MIL-DTL-3933, CLASS III/IV, N/S** Fixed Attenuators. Most Weinschel Fixed Coaxial Attenuators can be supplied according to customer specified testing, environmental or military or government specification requirements.

Hi-Rel units can be laser-marked and are manufactured from materials which have a TML of less than 1% and CVCM less than 0.1%. Refer to page 25 for more details.

What is a bidirectional and unidirectional attenuator?

All Aeroflex / Weinschel attenuators are bidirectional unless they are specified as unidirectional in the power rating specification. Bidirectional means the maximum specified power can be applied to either the input or output of the attenuator. Unidirectional means the maximum specified power can only be applied to the input port of the attenuator. Unidirectional designs allow for smaller overall package sizes and reduced costs. All our attenuators have maximum average and peak pulse input power limits. The average power limit decreases linearly as the ambient temperature increases. If these limits are exceeded, burnout of the attenuator element results or its calibration may be permanently changed. When used within its specifications, an attenuator is an indispensable component in measurement and system applications.

*Most designs, some features may not apply to certain low cost attenuator designs.

What dB values are available besides those in the catalog?

Most any dB value is available; however you should consult your local sales representative or the factory for design availability for a particular dB value for the selected model. There is generally an additional charge for non-catalog values.

Can Aeroflex / Weinschel provide attenuators for space applications?

Yes. Aeroflex / Weinschel fixed attenuators are being used on a wide variety of military and commercial communication satellites. "S" level fixed attenuators can be provided for any dB value up to 40 dB from dc to 40 GHz. Aeroflex / Weinschel has recently introduced Models 32 (page 24) and 32J (page 23) standard fixed attenuators that operates from dc to 18 or 32 GHz. These attenuators offer superior electrical and mechanical design that is ideally suited for space applications.

Aeroflex / Weinschel's use of precision connectors, injection molded captivation of connector contacts (no solder or contact fingers) and very precise and stable resistors result in a superior electrical and mechanical design that is ideally suited for space applications.

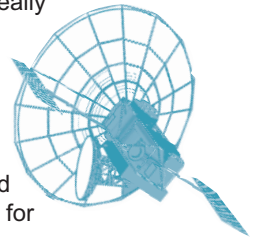

Aeroflex / Weinschel program experience includes:

Aussat (Optus)	SSTI	JCSAT
KOREASAT	GlobalStar	GEM
TDRSS	ICO	SMTS
TELSTAR	INTELSAT	AGILA
GOES	ACeS	MSAT
MILSTAR	EOS	TOMS

...and many others.

Aeroflex / Weinschel offers extensive testing programs for space qualified attenuators and other components that can include:

Random Vibration: Random and/or Sine Vibration up to 100 g rms.

Monitored Thermal Cycle: Units monitored for open condition over -55 to +85°C temperature range.

Thermal Shock: Performed per MIL-STD-202, Method 107.

Burn-In Testing: Performed at rated power and operating temperature from 96 to 360 hours typical.

Mechanical Shock: Performed per MIL-STD-202, Method 213 Test Condition F up to 1000 G peak.

Moisture Resistance Testing: Performed per MIL-STD-202, Method 106. (except sub-cycle 7b is not applicable) with connectors capped.

Salt Spray: Performed per MIL-STD-202, Method 101 with connectors capped.



Fixed Coaxial Attenuators



Can Weinschel provide special fixed attenuators?

Yes. Aeroflex / Weinschel has produced over 2000 custom fixed attenuator designs. Specials continue to be a significant part of Weinschel's product offering. Special features may include:

1. Custom Connector Configurations
2. Matched Pairs or Sets
3. Lower VSWR & Higher Accuracy
4. Special Mounting & Environmental Conditions
5. Unique Test Requirements & Data

Does Weinschel offer any attenuators with IM3 specified?

Yes Aeroflex / Weinschel has recently introduced new as well as updated models specifically for applications requiring low intermodulation distortion. Models are available with the low IM options are...24, 33, 40, 45, 46, 47, 48, 48, 53, 57, & 58. Refer to the page 17 for a product line overview or the specific data sheet for IM3 details.

How is the temperature or power coefficient specification applied?

These specifications tell how much the attenuation will change when the ambient temperature or input power changes. First multiply the catalog temperature coefficient or power coefficient by the ambient temperature range or input power range to which the attenuator will be exposed. Then multiply that number by the dB value of the attenuator. The result is the maximum change in attenuation than can be expected over the ambient temperature range or power range that was specified.

How is the attenuator power rating calculated?

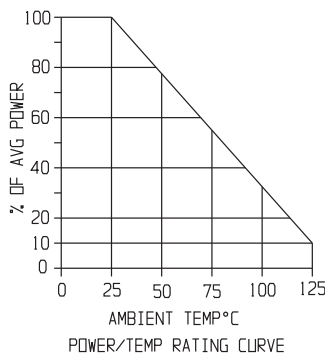

An attenuator will handle specified power at ambient temperatures as specified in the catalog. No special fan cooling is required. At higher temperatures the power rating is calculated by using catalog specifications and a straight line graph (Example shown above). For instance the power rating of the Model 48 attenuator is 100 watts at 25°C and 10 watts at

125°C. Using linear graph paper, plot a straight line between these two points. This plot shows that the power rating at 75°C is approximately 56 Watts.

Does Aeroflex / Weinschel offer attenuators sets or attenuation test kits?

Aeroflex / Weinschel offers a variety of attenuation standard sets consisting of precision designed fixed attenuators. These sets are ideally suited for standards and research laboratories as well as production, quality control, and inspection departments. Aeroflex / Weinschel attenuation sets are available in either 3, 6, 10, 20 dB or 1, 3, 6, 10, 20,

30 dB attenuation values. Each attenuator is tested in 1 GHz intervals to minimize interpolation error. The attenuator sets are available in stainless steel type N (Model 1 & 44), and 3.5mm (Model 56) connectors. Custom sets with other connector type and higher power sets are also available upon request. Refer to page 60 for more details.



What is Third-Order Intermodulation Distortion?

(IM3) Intermodulation distortion (IM) consists of the spurious signals which result from the mixing of nth order frequencies in the non-linear elements of a component. Third order intermodulation distortion is of particular interest because third order products typically represent the highest level distortion appearing close to the desired signal, and as such the highest level non-filterable distortion. Third order IM level (IM3) is tested by injecting two pure tones of equal magnitude (f1 and f2) into the component to be tested. The third order IM products will appear in the output spectrum at the frequencies 2f1-f2 and 2f2-f1. These products are characterized by defining their level (in dBc) relative to the fundamental output tones at either f1 or f2.

Applications....

Aeroflex / Weinschel Attenuators are used in a wide variety of applications in the electronic field for the control or measurement of radio frequency energy. Attenuators are used as accurate standards in the measurement of loss or gain by the RF substitution method. They are used as a means of extending the dynamic range of measuring equipment such as power meters, field intensity meters, spectrum analyzers, and amplifiers, or to prevent overloading of receivers and amplifiers. They also reduce, by masking, the effects of variable or mismatched impedances on such circuit elements as oscillator, T-junctions, mixers, etc.

Fixed Attenuators can satisfy almost any requirement involving a reduction in power. Attenuators designed and manufactured by Weinschel Corporation are very stable and remain precision calibrated over wide ranges of humidity, temperature, and other ambient conditions for long periods of time.

Fixed Attenuators....

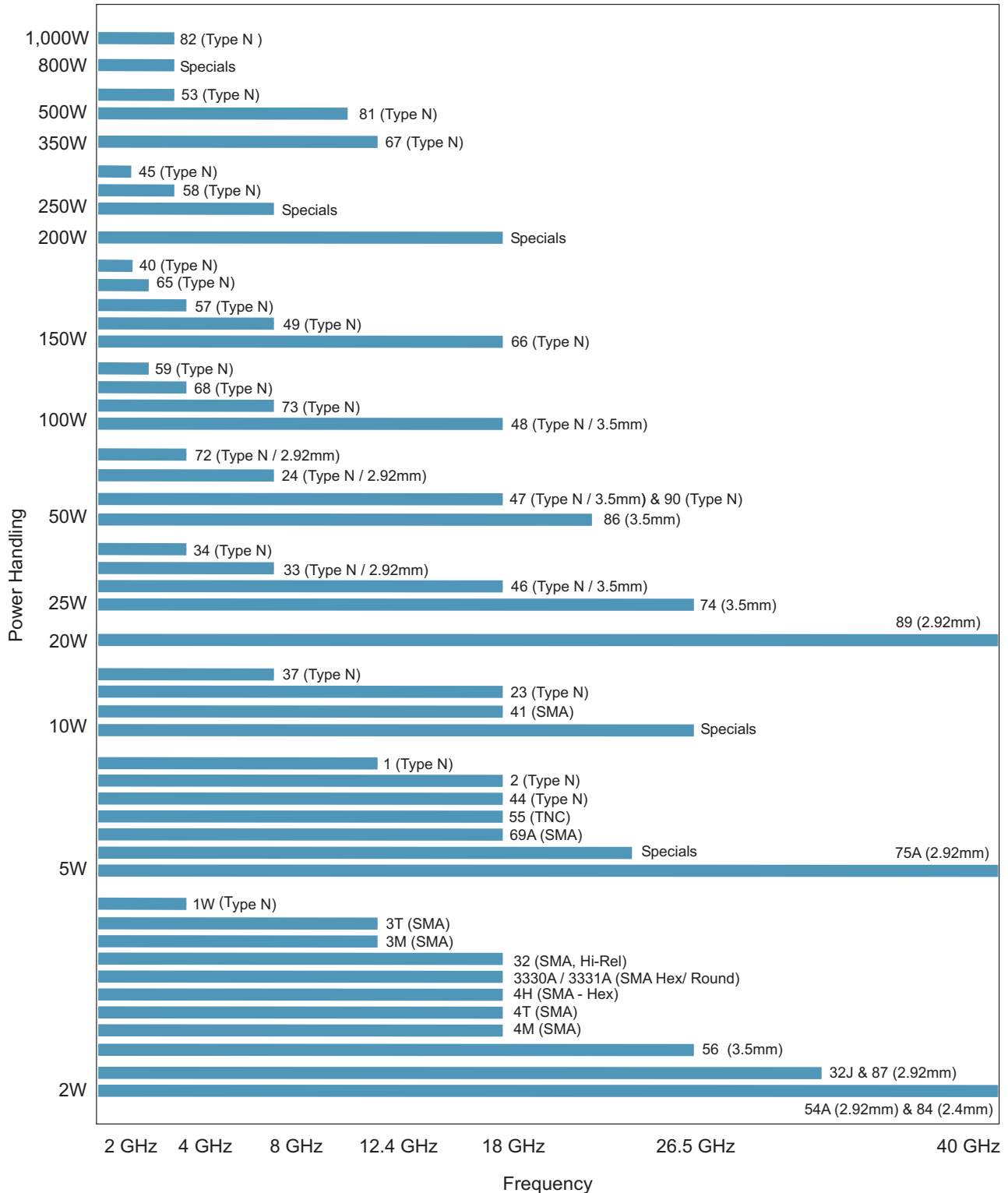

Attenuation Selection Guide: Power Handling / Frequency / Connector Type

Fixed Coaxial Attenuators



Models 3330A & 3331A General Purpose Attenuators

dc to 18.0 GHz
2 Watts

Low Cost Subminiature



Features

- /// **Low Cost** - These general purpose attenuators offer subminiature size, broadband frequency response, and attenuation values from 1 to 30 dB at low, competitive prices.
- /// **Two Configurations** - Round body Model 3330A and a hex body Model 3331A.
- /// **Ideal for Bulk Quantity Requirements.**

Specifications

NOMINAL IMPEDANCE: 50 Ω

FREQUENCY RANGE: dc to 18.0 GHz

MAXIMUM DEVIATION OVER FREQUENCY:	
Nominal ATTN (dB)	Deviation (dB)
0-6	± 0.30
7-10, 20	± 0.50
30	± 0.75

MAXIMUM SWR:	
Frequency (GHz)	SWR
dc - 4	1.15
4 - 12.4	1.30
12.4 - 18.0	1.40

POWER RATING: 2 watts **average** to 25°C ambient temperature, derated linearly to 0.5 watts @ 125°C. 250 watts **peak** (5 μsec pulse width; 0.4% duty cycle).

TEMPERATURE RANGE: -55°C to +125°C.

CONNECTORS: SMA connectors per MIL-STD-348 interface dimensions mate nondestructively with MIL-C-39012 connectors.

CONSTRUCTION: Passivated stainless steel body and connectors; gold plated beryllium copper contacts.

WEIGHT: 5.6 g (0.2 oz) maximum (Both Models)

PHYSICAL DIMENSIONS:

Model 3330A (Round):

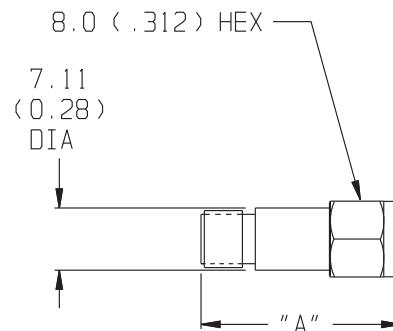

Model 3331A (Hex):

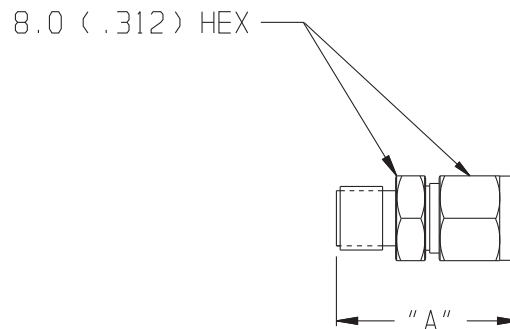

dB VALUE	DIM A
1 - 10	21.72 ± 0.51 (0.855 ± 0.020)
20, 30	25.02 ± 0.51 (0.985 ± 0.020)

NOTE:

1. All dimensions are given in mm (inches) and are maximum, unless otherwise specified.
2. Unit available with RoHS compliant materials, specify when ordering.

MODEL NUMBER DESCRIPTION:

Example:

3330A - XX

Basic Model Number

Attenuation Value (dB)

Model 4H Hex Body Attenuator

dc to 18.6 GHz
2 Watts

Precision SMA Connectors

RoHS



Features

- /// **Subminiature** - These attenuators offer the smallest package size with broadband frequency response, and attenuation values from 0 to 10, 12, 15, 20 & 30 dB.
- /// **Designed to meet environmental requirements of MIL-DTL-3933.**
- /// **Precision SMA Connectors.**
- /// **Usable to 23 GHz.**

Specifications

NOMINAL IMPEDANCE: 50 Ω

FREQUENCY RANGE: dc to 18.6 GHz

MAXIMUM DEVIATION OVER FREQUENCY:	
Nominal ATTN (dB)	Deviation (dB)
0	± 0.40
1-10	± 0.30
12, 15, 20, 30	± 0.70

MAXIMUM SWR:	
Frequency (GHz)	SWR
dc - 12.4	1.25
12.4 - 18.6	1.35

POWER RATING: 2 watts **average** to 25°C ambient temperature, derated linearly to 0.5 watts @ 125°C. 250 watts **peak** (5 μsec pulse width; 1% duty cycle).

POWER COEFFICIENT: < 0.005 dB/dB/watt

TEMPERATURE COEFFICIENT: < 0.0004 dB/dB/°C

TEMPERATURE RANGE: -50°C to +125°C

CONNECTORS: SMA connectors per MIL-STD-348 interface dimensions mate nondestructively with MIL-C-39012 connectors.

CONSTRUCTION: Stainless steel body and connectors; gold plated beryllium copper contacts.

WEIGHT: 5.0 g (0.18 oz) maximum

PHYSICAL DIMENSIONS:

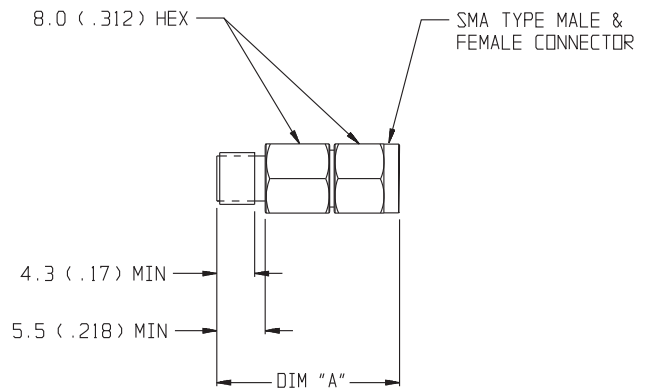

dB VALUE	DIM A
0-10	19.0 (0.75)
12, 15, 20	21.6 (0.85)
30	24.0 (0.95)

NOTE:

1. All dimensions are given in mm (inches) and are maximum, unless otherwise specified.
2. Unit available with RoHS compliant materials, specify when ordering.

MODEL NUMBER DESCRIPTION:

Example:

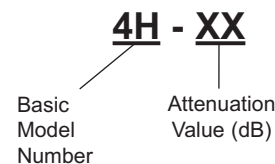

Fixed Coaxial Attenuators



Model 3M Model 4M Fixed Coaxial Attenuators

dc to 12.4 GHz
dc to 18.0 GHz
2 Watts

Ruggedized SMA Connectors



Features

- /// Rugged injection molded connectors.
- /// Designed to meet environmental requirements of MIL-DTL-3933.
- /// Usable to 22 GHz.

Specifications

NOMINAL IMPEDANCE: 50 Ω

FREQUENCY RANGE: Model 3M: dc to 12.4 GHz
Model 4M: dc to 18.0 GHz

MAXIMUM DEVIATION OVER FREQUENCY:		
Nominal ATTN (dB)	3M	4M
1 - 2	± 0.30	± 0.50
3 - 6	± 0.30	± 0.30
7 - 10	± 0.30	± 0.50
20	± 0.50	± 0.70
30, 40	± 0.75	± 1.00
50, 60	± 1.00	± 2.00

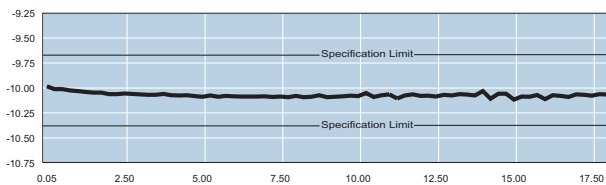

Typical Attenuation Performance of 4M-10

MAXIMUM SWR:		
Frequency (GHz)	3M	4M
dc - 4	1.15	1.15
4 - 8	1.20	1.20
8 - 12.4	1.25	1.25
12.4 - 18	---	1.35

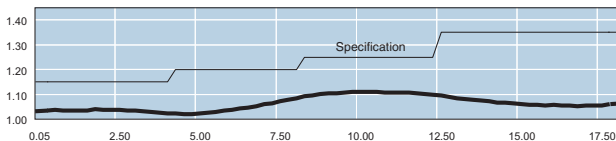

Typical SWR of a Model 4M-10

POWER RATING: 2 watts **average** to 25°C ambient temperature, derated linearly to 0.5 watts at 125°C. 500 watts **peak** (5 μsec pulse width; 0.2% duty cycle).

POWER COEFFICIENT: < 0.005 dB/dB/watts

TEMPERATURE COEFFICIENT: < 0.0004 dB/dB/°C

TEMPERATURE RANGE: -55°C to +125°C

TEST DATA: Insertion Loss and SWR Testing performed across frequency range. Test data available at additional cost.

CONNECTORS: SMA connectors per MIL-STD-348 interface dimensions - mate nondestructively with MIL-C-39012 connectors.

CONSTRUCTION: Passivated stainless steel body and connectors; gold plated beryllium copper contacts.

WEIGHT (Both Models):

dB VALUE	WEIGHT (Net)
1 - 10, 20	10 g (0.35 oz)
30, 40, 50, 60	20 g (0.70 oz)

PHYSICAL DIMENSIONS:

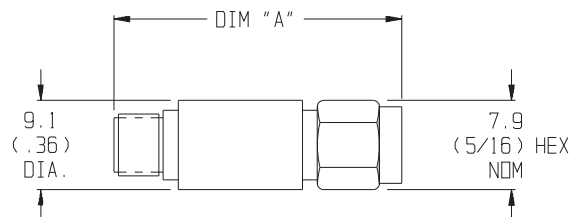

dB VALUE	DIM A ± 0.5 (0.02)
1 - 10, 20	30.5 (1.20)
30, 40, 50, 60	47.0 (1.85)

NOTE:

1. All dimensions are given in mm (inches) and are maximum, unless otherwise specified.
2. 4M available with RoHS compliant materials, specify when ordering.

MODEL NUMBER DESCRIPTION:

Example:

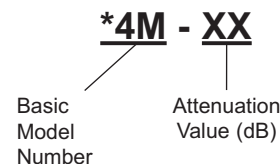

*Add Prefix M for double male and F for double female connectors.

Model 3T Model 4T Fixed Coaxial Attenuators

dc to 12.4 GHz
dc to 18.0 GHz
2 Watts

Ruggedized SMA Connectors



Features

- /// Rugged injection molded connectors.
- /// Designed to meet environmental requirements of MIL-DTL-3933.
- /// Small Package Size
- /// Usable to 22 GHz.

Specifications

NOMINAL IMPEDANCE: 50 Ω

FREQUENCY RANGE: Model 3T: dc to 12.4 GHz
Model 4T: dc to 18.0 GHz

MAXIMUM DEVIATION OVER FREQUENCY:		
Nominal ATTN (dB)	3T	4T
1 - 6	± 0.30	± 0.30
7 - 12	± 0.30	± 0.50
20	± 0.50	± 0.70
30, 40	± 0.75	± 1.00
50, 60	± 1.00	± 1.50

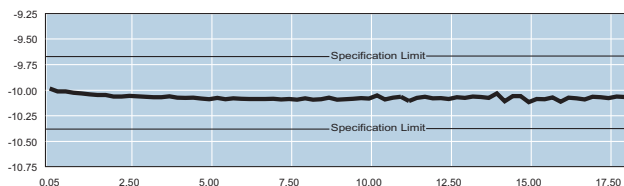

Typical Attenuation Performance of 4T-10

MAXIMUM SWR:		
Frequency (GHz)	3T	4T
dc - 4	1.15	1.15
4 - 8	1.20	1.20
8 - 12.4	1.25	1.25
12.4 - 18	---	1.35

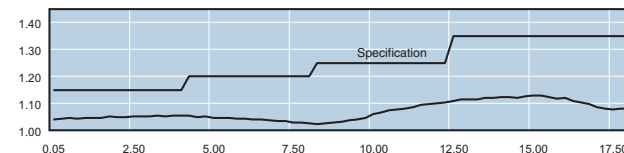

Typical SWR of a Model 4T-10

POWER RATING: 2 watts **average** to 25°C ambient temperature, derated linearly to 0.5 watts at 125°C. 500 watts **peak** (5 μsec pulse width; 0.2% duty cycle).

POWER COEFFICIENT: < 0.005 dB/dB/watts

TEMPERATURE COEFFICIENT: < 0.0004 dB/dB/°C

TEMPERATURE RANGE: -55°C to +125°C

TEST DATA: Insertion Loss and SWR Testing performed across frequency range. Test data available at additional cost.

CONNECTORS: SMA connectors per MIL-STD-348 interface dimensions - mate nondestructively with MIL-C-39012 connectors.

CONSTRUCTION: Passivated stainless steel body and connectors; gold plated beryllium copper contacts.

WEIGHT (Both Models):

dB VALUE	WEIGHT (Net)
1 - 12	3.9 g (0.14 oz)
20	4.3 g (0.15 oz)
30	4.9 g (0.17 oz)
40, 50, 60	6.5 g (0.23 oz)

PHYSICAL DIMENSIONS:

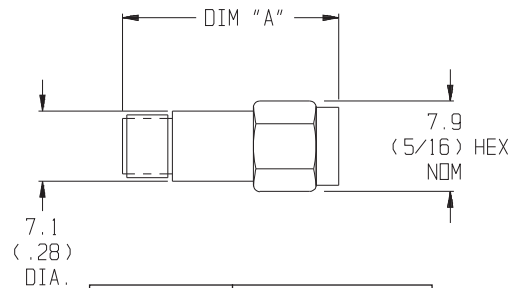

dB VALUE	DIM A ± 0.5 (0.02)
1 - 12	21.8 (0.86)
20	23.9 (0.94)
30	26.5 (1.04)
40, 50, 60	34.0 (1.85)

NOTE:

1. All dimensions are given in mm (inches) and are maximum, unless otherwise specified.
2. Unit available with RoHS compliant materials, specify when ordering.

MODEL NUMBER DESCRIPTION:

Example:

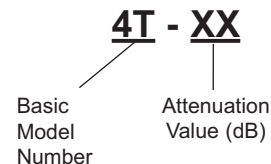

Fixed Coaxial Attenuators



Model 32 High Reliability Fixed Coaxial Attenuator

dc to 18.0 GHz
2 Watts

Suitable for Space & Airborne Applications



Features

- /// Available in 0.5 dB increments from 0-20 dB.
- /// Rugged injection molded connectors.
- /// Designed to meet environmental requirements of MIL-DTL-3933.
- /// 100% Subjected to Thermal Shock & Peak Power Tests.

Specifications

NOMINAL IMPEDANCE: 50 Ω

FREQUENCY RANGE: dc to 18.0 GHz

MAXIMUM DEVIATION OVER FREQUENCY:	
Nominal ATTN (dB)	Deviation (dB)
0	+ 0.30
0.5 - 6	± 0.30
6.5 - 12	± 0.50
12.5 - 20	± 0.70

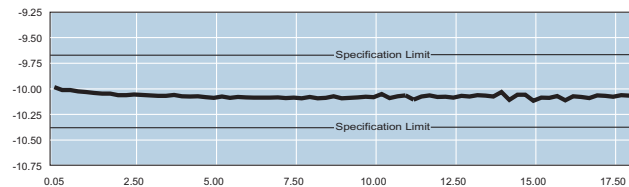

Typical Attenuation Accuracy of 32-10

MAXIMUM SWR:	
Frequency (GHz)	SWR
dc - 4	1.15
4 - 8	1.20
8 - 12.4	1.25
12.4 - 18	1.35

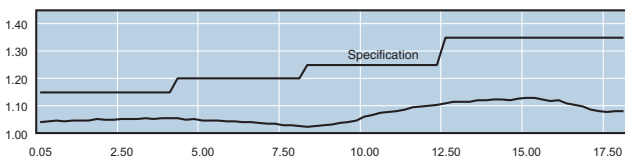

Typical SWR of a 32-10

POWER RATING: 2 watts **average** to 25°C ambient temperature, derated linearly to 0.5 watts at 125°C. 500 watts **peak** (5 μsec pulse width; 0.2% duty cycle).

POWER COEFFICIENT: < 0.005 dB/dB/watts

TEMPERATURE COEFFICIENT: < 0.0004 dB/dB/°C

TEMPERATURE RANGE: -55°C to +125°C

CONNECTORS: SMA connectors per MIL-STD-348 interface dimensions - mate nondestructively with MIL-C-39012 connectors.

CONSTRUCTION: Passivated stainless steel body and connectors; gold plated beryllium copper contacts. Each unit is sealed using low outgassing sealant.

WEIGHT:

dB VALUE	WEIGHT (Net)
0 - 12	3.9 g (0.14 oz)
12.5 - 20	4.3 g (0.15 oz)

PHYSICAL DIMENSIONS:

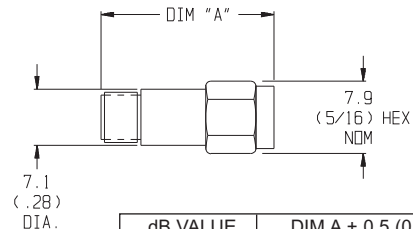

dB VALUE	DIM A ± 0.5 (0.02)
0-12	21.8 (0.86)
12.5-20	23.9 (0.94)

NOTE:

1. All dimensions are given in mm (inches) and are maximum, unless otherwise specified.
2. Unit available with RoHS compliant materials, specify when ordering.

Screening

Units are screened by lot as follows:

Thermal Shock: 10 cycles, -55 C to +125 °C, with a minimum of 1/2 hour dwell time at each temperature extreme. Attenuation is measured before and after thermal shock.

Peak Power: 500 Watts, 5 μsec pulse width; 0.05% duty cycle for 3 minutes at each end. DC Attenuation is measured before and after peak power.

Attenuation and SWR are tested as final electrical test. Test data is available at additional cost.

MODEL NUMBER DESCRIPTION:

Example:

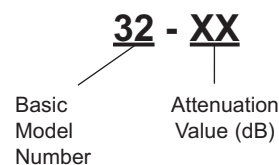

Models 32J High Reliability Fixed Coaxial Attenuator

dc to 32.0 GHz
2 Watts

Suitable for Space & Airborne Applications



Features

- /// Available in 0.5 dB increments from 0-30 dB.
- /// Rugged injection molded connectors.
- /// Designed to meet environmental requirements of MIL-DTL-3933.
- /// 100% Subjected to Thermal Shock & Peak Power Tests.

Specifications

NOMINAL IMPEDANCE: 50 Ω

FREQUENCY RANGE: dc to 32.0 GHz

MAXIMUM DEVIATION OVER FREQUENCY:	
Nominal ATTN (dB)	Deviation (dB)
0	+ 0.5 / -0.0
0.5 - 12	± 0.50
12.5 - 20	± 1.00
20.5 - 30	± 2.00

MAXIMUM SWR:	
Frequency (GHz)	SWR
dc - 32	1.25

POWER RATING: 2 watts **average** to 25°C ambient temperature, derated linearly to 0.5 watts at 100°C. 500 watts **peak** (5 μsec pulse width; 0.2% duty cycle).

POWER COEFFICIENT: < 0.005 dB/dB/watts

TEMPERATURE COEFFICIENT: < 0.0004 dB/dB/°C

TEMPERATURE RANGE: -55°C to +100°C

CONNECTORS: 2.92mm connectors - mate nondestructively with SMA connectors per MIL-C-39012, 3.5mm, SMK, and other 2.92mm connectors.

CONSTRUCTION: Passivated stainless steel body and connectors; gold plated beryllium copper contacts. Each unit is sealed using low outgassing sealant.

WEIGHT: 13 g (0.46 oz)

PHYSICAL DIMENSIONS:

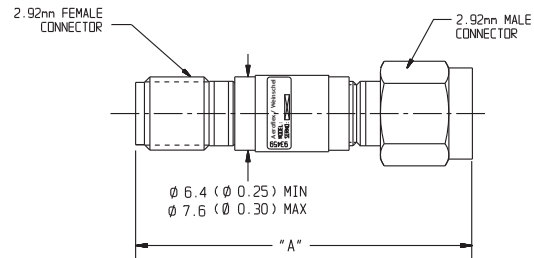

dB VALUE	DIM A ± 0.5 (0.02)
0-12	28.6 (1.15)
12.5-20	31.2 (1.23)
20.5-30	33.8 (1.33)

NOTE:

1. All dimensions are given in mm (inches) and are maximum, unless otherwise specified.
2. Unit available with RoHS compliant materials, specify when ordering.

Screening

Units are screened by lot as follows:

Thermal Shock: 10 cycles, -55 C to +100 °C, with a minimum of 1/2 hour dwell time at each temperature extreme. Attenuation is measured before and after thermal shock.

Peak Power: 500 Watts, 5 μsec pulse width; 0.05% duty cycle for 3 minutes at each end. DC Attenuation is measured before and after peak power.

Attenuation and SWR are tested as final electrical test. Test data is available at additional cost.

MODEL NUMBER DESCRIPTION:

Example:

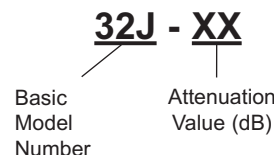

EXPORT CONTROL:

This product is controlled for export under the International Traffic in Arms Regulations (ITAR). A license from the U.S. Department of State is required prior to the export of this product from the United States.

EXPORT WARNING:

Aeroflex's military and space products are controlled for export under the International Traffic in Arms Regulations (ITAR) and may not be sold or proposed or offered for sale to certain countries. (See ITAR 126.1 for complete information.)

Models 32J High Reliability Fixed Coaxial Attenuator

dc to 32.0 GHz
2 Watts

Suitable for Space & Airborne Applications



Features

- /// Available in 0.5 dB increments from 0-30 dB.
- /// Rugged injection molded connectors.
- /// Designed to meet environmental requirements of MIL-DTL-3933.
- /// 100% Subjected to Thermal Shock & Peak Power Tests.

Specifications

NOMINAL IMPEDANCE: 50 Ω

FREQUENCY RANGE: dc to 32.0 GHz

MAXIMUM DEVIATION OVER FREQUENCY:

Nominal ATTN (dB)	Deviation (dB)
0	+ 0.5 / -0.0
0.5 - 12	± 0.50
12.5 - 20	± 1.00
20.5 - 30	± 2.00

MAXIMUM SWR:

Frequency (GHz)	SWR
dc - 32	1.25

POWER RATING: 2 watts **average** to 25°C ambient temperature, derated linearly to 0.5 watts at 100°C. 500 watts **peak** (5 μsec pulse width; 0.2% duty cycle).

POWER COEFFICIENT: < 0.005 dB/dB/watts

TEMPERATURE COEFFICIENT: < 0.0004 dB/dB/°C

TEMPERATURE RANGE: -55°C to +100°C

CONNECTORS: 2.92mm connectors - mate nondestructively with SMA connectors per MIL-C-39012, 3.5mm, SMK, and other 2.92mm connectors.

CONSTRUCTION: Passivated stainless steel body and connectors; gold plated beryllium copper contacts. Each unit is sealed using low outgassing sealant.

WEIGHT: 13 g (0.46 oz)

PHYSICAL DIMENSIONS:

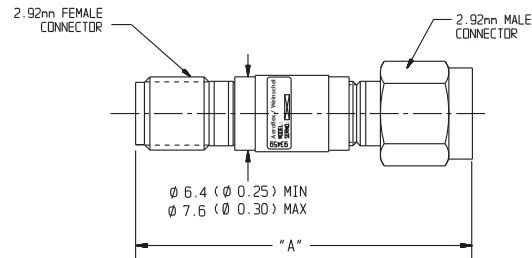

dB VALUE	DIM A ± 0.5 (0.02)
0-12	28.6 (1.15)
12.5-20	31.2 (1.23)
20.5-30	33.8 (1.33)

NOTE:

1. All dimensions are given in mm (inches) and are maximum, unless otherwise specified.
2. Unit available with RoHS compliant materials, specify when ordering.

Screening

Units are screened by lot as follows:

Thermal Shock: 10 cycles, -55 C to +100 °C, with a minimum of 1/2 hour dwell time at each temperature extreme. Attenuation is measured before and after thermal shock.

Peak Power: 500 Watts, 5 μsec pulse width; 0.05% duty cycle for 3 minutes at each end. DC Attenuation is measured before and after peak power.

Attenuation and SWR are tested as final electrical test. Test data is available at additional cost.

MODEL NUMBER DESCRIPTION:

Example:

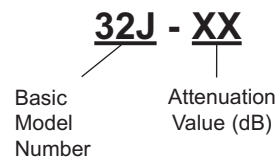

EXPORT CONTROL:

This product is controlled for export under the International Traffic in Arms Regulations (ITAR). A license from the U.S. Department of State is required prior to the export of this product from the United States.

EXPORT WARNING:

Aeroflex's military and space products are controlled for export under the International Traffic in Arms Regulations (ITAR) and may not be sold or proposed or offered for sale to certain countries. (See ITAR 126.1 for complete information.)

Fixed Coaxial Attenuators



Model 87 Fixed Coaxial Attenuator

dc to 32.0 GHz
2 Watts

Quality 2.92mm Connectors



Features

- /// Available in 0.5 dB increments from 0-30 dB.
- /// Rugged injection molded connectors.
- /// Designed to meet environmental requirements of MIL-DTL-3933.
- /// New Lower Cost Commercial Version.

Specifications

NOMINAL IMPEDANCE: 50 Ω

FREQUENCY RANGE: dc to 32.0 GHz

MAXIMUM DEVIATION OVER FREQUENCY:

Nominal ATTN (dB)	Deviation (dB)
0	+ 0.5 / -0.0
0.5 - 12	± 0.50
12.5 - 20	± 1.00
20.5 - 30	± 2.00

MAXIMUM SWR:

Frequency (GHz)	SWR
dc - 32	1.25

POWER RATING: 2 watts **average** to 25°C ambient temperature, derated linearly to 0.5 watts at 100°C. 500 watts **peak** (5 μsec pulse width; 0.2% duty cycle).

POWER COEFFICIENT: < 0.005 dB/dB/watts

TEMPERATURE COEFFICIENT: < 0.0004 dB/dB/°C

TEMPERATURE RANGE: -55°C to +100°C

TESTING & CALIBRATION Attenuation and SWR are tested as final electrical test. Test data is available at additional cost.

CONNECTORS: 2.92mm connectors - mate nondestructively with SMA connectors per MIL-C-39012, 3.5mm, SMK, and other 2.92mm connectors.

CONSTRUCTION: Passivated stainless steel body and connectors; gold plated beryllium copper contacts.

WEIGHT: 8 g (0.28 oz)

PHYSICAL DIMENSIONS:

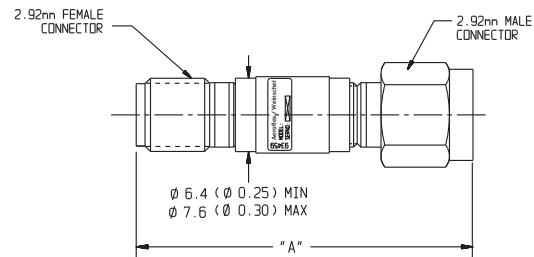

dB VALUE	DIM A ± 0.5 (0.02)
0-12	28.6 (1.15)
12.5-20	31.2 (1.23)
20.5-30	33.8 (1.33)

NOTE: All dimensions are given in mm (inches) and are maximum, unless otherwise specified.

MODEL NUMBER DESCRIPTION:

Example:

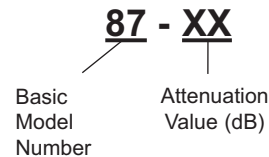

Military-Qualified Attenuators

dc to 18.0 GHz
2 to 25 Watts

MIL-DTL-3933, CLASS III/IV, N/S

Features

- /// Screened and Non-screened models available.
- /// Choice of attenuation values from 0 to 40 dB.
- /// Frequency Ranges from dc to 18 GHz.
- /// Power capability from 2 to 25 watts.
- /// Test Data supplied per MIL-DTL-3933.
- /// Type N, SMA, & TNC Connectors.



MIL-DTL-3933 Basic Information...

Military Part Number	Description *	Outline Drawing/ Dimensions
M3933/10 (-2 through -21) Non-Screened (N), Screened (S)	dc to 18 GHz 25 Watts Average; 2 kW peak	Refer to Aeroflex / Weinschel Standard Model 46 (page 41)
M3933/14 (-01 through -14, -17 through -24) Non-Screened (N), Screened (S)	dc to 12.4 GHz 2 watts Average; 200 W peak	Refer to Aeroflex / Weinschel Standard Model 3M (page 21)
M3933/16 (-01 through -13, -16 through -51, -57, -58) Non-Screened (N), Screened (S)	dc to 18 GHz 2 watts Average; 500 W peak	Refer to Aeroflex / Weinschel Standard Model 4M (page 21).
M3933/17 (-01, -02) Non-Screened (N), Screened (S)	dc to 18 GHz 4 watts Average; 500 W peak	Refer to Aeroflex / Weinschel Standard Model 55 (page 30).
M3933/18 (-01 through -06, -09 through -18) Non-Screened (N), Screened (S)	dc to 12.4 GHz 5 watts Average; 1 kW peak	Refer to Aeroflex / Weinschel Standard Model 1 (page 31).
M3933/25 (-01 through -54, -58 through -92) Non-Screened (N), Screened (S)	dc to 18.0 GHz 2 watts Average; 500 W peak	Refer to Aeroflex / Weinschel Standard Model 3T/4T (page 22).

*For complete specifications and ordering information refer to Military Specification, MIL-DTL-3933.

Fixed Coaxial Attenuators



Model 56 Fixed Coaxial Attenuator

dc to 28.0 GHz
2 Watts

3.5mm Connectors



Features

- /// Precision 3.5mm Connectors.
- /// Low SWR & Flat Response.
- /// Bulkhead ideal for instrument front panels.

Specifications

NOMINAL IMPEDANCE: 50 Ω

FREQUENCY RANGE: dc to 28.0 GHz

MAXIMUM DEVIATION OVER FREQUENCY (dB):	
Nominal ATTN (dB)	DEVIATION (dB)
0	+ 0.50
3, 6, 10	± 0.60
20, 30	± 0.75

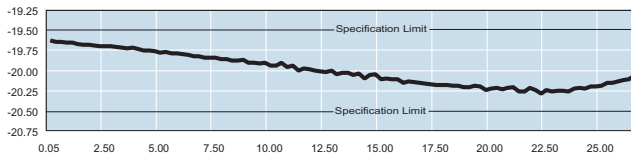

Typical Attenuation Accuracy of a 56-20

MAXIMUM SWR:	
Frequency (GHz)	SWR
dc - 8	1.10
8 - 12.4	1.15
12.4 - 28	1.25

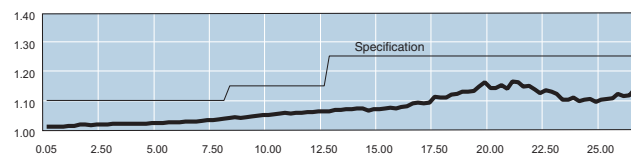

Typical SWR of a 56-20

POWER RATING: 2 watts **average** to 25°C ambient temperature, derated linearly to 0.5 watts at 85°C. 500 watts **peak** (5 μsec pulse width; 0.2% duty cycle).

POWER COEFFICIENT: < 0.005 dB/dB/watts

TEMPERATURE COEFFICIENT: < 0.0004 dB/dB/°C

TEMPERATURE RANGE: -55 °C to +85 °C.

TEST DATA: Insertion Loss and SWR Testing performed across frequency range. Test data available at additional cost.

CONNECTORS: 3.5mm connectors - contact pin recession (0 to -0.003 in).

CONSTRUCTION: Stainless steel body and connectors; gold plated beryllium copper contacts.

WEIGHT: 10 g (0.28 oz) maximum

PHYSICAL DIMENSIONS:

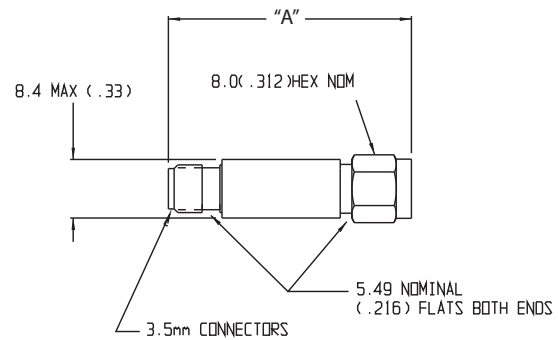

Model	DIM A
56	32.5±0.5 (1.275±0.002)
F56	35.9±0.5 (1.415±0.002)
M56	29.0±0.5 (1.140±0.002)

NOTE:

1. All dimensions are given in mm (inches) and are maximum, unless otherwise specified.
2. Unit available with RoHS compliant materials, specify when ordering.

MODEL NUMBER DESCRIPTION:

Example:

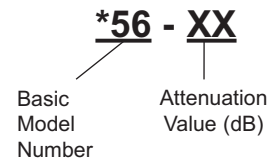

* Add Prefix M for double male and F for double female connectors.

ATTENUATOR SET (AS-20): Model 56 is also available in a Attenuator Set which includes five different attenuators (3, 6, 10, 20, 30 dB). Refer to Attenuator Sets data sheet for more information.

Model 54A Fixed Coaxial Attenuator

dc to 42.0 GHz
2 Watts

Ruggedized 2.92mm Connectors



Features

- Designed to meet environmental requirements of MIL-DTL-3933.
- Ruggedized 2.92mm Connectors.

Specifications

NOMINAL IMPEDANCE: 50 Ω
FREQUENCY RANGE: dc to 42.0 GHz

MAXIMUM DEVIATION OVER FREQUENCY:		
Nominal ATTN (dB)	Deviation (dB)	
	dc-26.5	26.5-42
3, 6	± 0.50	± 1.00
10, 20	± 1.00	± 1.00
30	± 2.00	± 2.00

MAXIMUM SWR:	
Frequency (GHz)	SWR
dc - 26.5	1.25
26.5 - 42	1.45

POWER RATING: 2 watts **average** to 25 °C ambient temperature, derated linearly to 0.1 watt at 85 °C. 200 watts **peak** (5 μsec pulse width; 0.5 % duty cycle).

POWER COEFFICIENT: < 0.004 dB/dB/watts

TEMPERATURE COEFFICIENT: < 0.0004 dB/dB/°C

TEMPERATURE RANGE: -55 °C to +100 °C

TEST DATA: Insertion Loss and SWR Testing performed across frequency range. Test data available at additional cost.

CONNECTORS: 2.92mm connectors - mate nondestructively with SMA connectors per MIL-C-39012, 3.5mm, SMK, and other 2.92mm connectors.

CONSTRUCTION: Stainless steel body and connectors; gold plated beryllium copper contacts.

WEIGHT: 13 g (0.46 oz.) maximum

PHYSICAL DIMENSIONS:

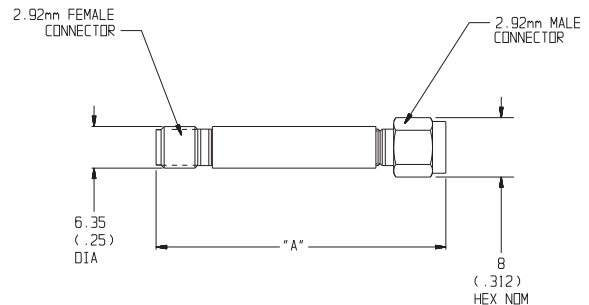

Model	DIM A
54A	39.9 (1.57)
F54A	37.9 (1.49)
M54A	42.0 (1.64)

NOTE: All dimensions are given in mm (inches) and are maximum, unless otherwise specified.

MODEL NUMBER DESCRIPTION:

Example:

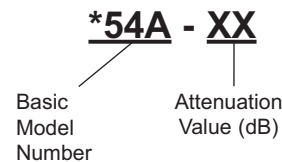

* Add Prefix M for double male and F for double female connectors.

Fixed Coaxial Attenuators



Model 84A Fixed Coaxial Attenuator

dc to 40.0 GHz
2 Watts

2.4mm Connectors



Features

- /// Useable to 43 GHz.
- /// Designed to meet environmental requirements of MIL-DTL-3933.
- /// Ruggedized 2.4mm Connectors.

Specifications

NOMINAL IMPEDANCE: 50 Ω
FREQUENCY RANGE: dc to 40.0 GHz

MAXIMUM DEVIATION OVER FREQUENCY:			
Nominal ATTN (dB)	Deviation (dB)		
	dc-18.0	18-26.5	26.5-40
3	± 0.60	± 0.70	± 1.10
6	± 0.60	± 0.70	± 1.00
10	± 0.60	± 0.80	± 1.00
20	± 0.70	± 1.00	± 1.00
30	± 1.00	± 1.40	± 1.40

MAXIMUM SWR:	
Frequency (GHz)	SWR
dc - 26.5	1.35
26.5 - 40	1.50

POWER RATING: 2 watts **average** to 25 °C ambient temperature, derated linearly to 0.1 watt at 125 °C. 200 watts **peak** (5 μsec pulse width; 0.5 % duty cycle).

POWER COEFFICIENT: < 0.01 dB/dB/watts

TEMPERATURE COEFFICIENT: < 0.001 dB/dB/°C

TEMPERATURE RANGE: -55°C to +125°C

TEST DATA: Insertion Loss and SWR Testing performed across frequency range. Test data available at additional cost.

CONNECTORS: 2.4mm connectors mate nondestructively with other 2.4mm connectors. Contact Pin Recession (0 to 0.003)

CONSTRUCTION: Stainless steel body; gold plated beryllium copper contacts and brass connectors.

WEIGHT: 13 g (0.46 oz.) maximum

PHYSICAL DIMENSIONS:

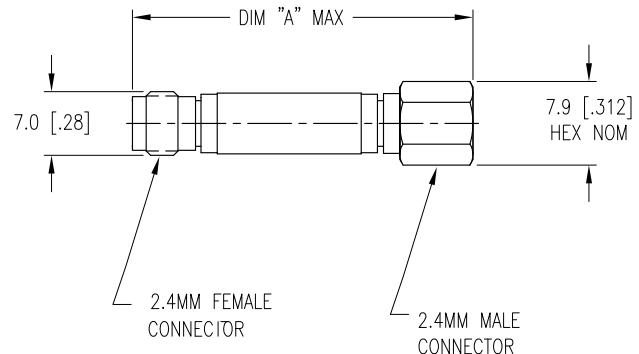

Model	DIM A
84A	38.10 (1.50)
F84A	34.00 (1.34)
M84A	42.20 (1.66)

NOTE:

1. All dimensions are given in mm (inches) and are maximum, unless otherwise specified.
2. Unit available with RoHS compliant materials, specify when ordering.

MODEL NUMBER DESCRIPTION:

Example:

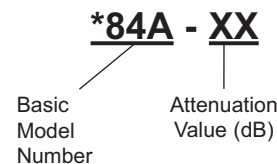

* Add Prefix M for double male and F for double female connectors.

Model 1W General Purpose Attenuator

dc to 4.0 GHz
2 Watts

Low Cost, Type N



CONNECTORS: Type N (male/female) connectors - mate nondestructively with MIL-C-39012 connectors.

CONSTRUCTION: Nickel-plated brass body and connectors, gold plated Beryllium contacts

WEIGHT: 65 g (2.5 oz) maximum

PHYSICAL DIMENSIONS:

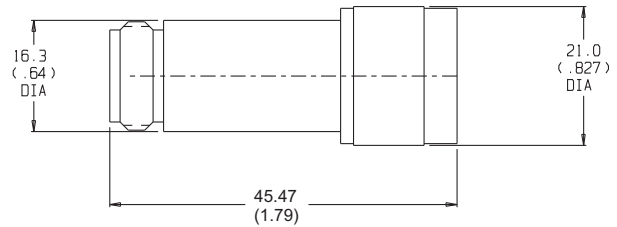

Features

- /// **Attenuation Values from 1 to 10, 20 dB.**
- /// **Low Cost**
- /// **Wireless Applications** - Optimized for use in the wireless communications bands.

Specifications

NOMINAL IMPEDANCE: 50 Ω

FREQUENCY RANGE: dc to 4.0 GHz

MAXIMUM DEVIATION OVER FREQUENCY:	
Nominal ATTN (dB)	Deviation (dB)
1 -6	± 0.30
7 -10, 20	± 0.50

MAXIMUM SWR:	
Frequency (GHz)	SWR
dc - 8.0	1.25

POWER RATING: 2 watts **average** to 25°C ambient temperature, derated linearly to 0.5 watts @ 105°C. 250 watts **peak** (5 μsec pulse width; 0.4% duty cycle).

POWER COEFFICIENT: < 0.005 dB/dB/watt

TEMPERATURE COEFFICIENT: < 0.0004 dB/dB/°C

TEMPERATURE RANGE: -20°C to +105°C.

NOTE:

1. All dimensions are given in mm (inches) and are maximum, unless otherwise specified.
2. Unit available with RoHS compliant materials, specify when ordering.

MODEL NUMBER DESCRIPTION:

Example:

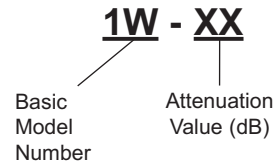

Fixed Coaxial Attenuators



Model 55 Fixed Coaxial Attenuator

dc to 18.0 GHz
5 Watts

TNC Connectors



Features

- /// **Quality TNC Connectors** - This Attenuator incorporates an improved 18 GHz TNC connector design standardized through the IEC.
- /// **Designed to meet environmental requirements of MIL-DTL-3933.**

Specifications

NOMINAL IMPEDANCE: 50 Ω

FREQUENCY RANGE: dc to 18.0 GHz

MAXIMUM DEVIATION OVER FREQUENCY:	
Nominal ATTN (dB)	Deviation (dB)
1 -6	± 0.40
7 -10, 20	± 0.50
30	± 0.90

MAXIMUM SWR:	
Frequency (GHz)	SWR
dc - 4	1.15
4 - 8	1.20
8 - 12.4	1.25
12.4 - 18	1.35

POWER RATING: 5 watts **average** @ 25°C ambient temperature, derated linearly to 0.5 watt @ 125°C. 1 kilowatt **peak** (5 μsec pulse width; 0.0005% duty cycle).

POWER COEFFICIENT: < 0.005 dB/dB/watt

TEMPERATURE COEFFICIENT: < 0.0004 dB/dB/ °C

TEMPERATURE RANGE: -55°C to +125°C

TEST DATA: Insertion Loss and SWR Testing performed across frequency range. Test data available at additional cost.

CONNECTORS: TNC connectors per MIL-STD-348 interface dimensions - mate nondestructively with MIL-C-39012 connectors.

CONSTRUCTION: Stainless steel body and connectors; gold plated beryllium copper contacts.

WEIGHT: 28 g (1 oz) maximum

PHYSICAL DIMENSIONS:

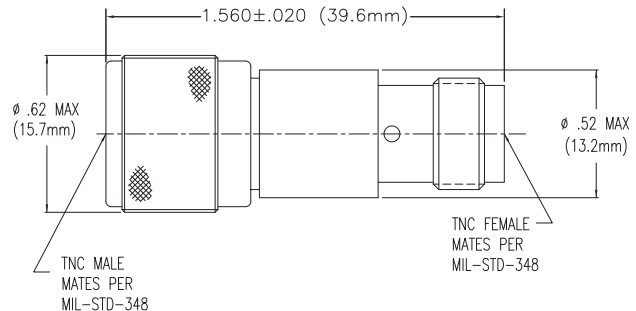

NOTE:

1. All dimensions are given in mm (inches) and are maximum, unless otherwise specified.
2. Unit available with RoHS compliant materials, specify when ordering.

MODEL NUMBER DESCRIPTION:

Example:

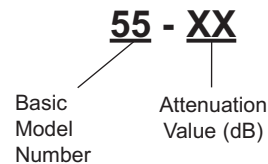

Model 1 Model 2 Fixed Coaxial Attenuators

dc to 12.4 GHz
dc to 18.0 GHz
5 Watts

RoHS

Type N Connectors



Features

- /// Rugged injection molded connectors.
- /// Designed to meet environmental requirements of MIL-DTL-3933.

Specifications

NOMINAL IMPEDANCE: 50 Ω

FREQUENCY RANGE: Model 1: dc to 12.4 GHz
Model 2: dc to 18.0 GHz

MAXIMUM DEVIATION OVER FREQUENCY:		
Nominal ATTN (dB)	1	2
1-9	± 0.30	± 0.30
10, 20	± 0.30	± 0.50
30, 40	± 0.75	± 1.00
50	± 0.75	± 1.25
60	± 1.00	± 1.50

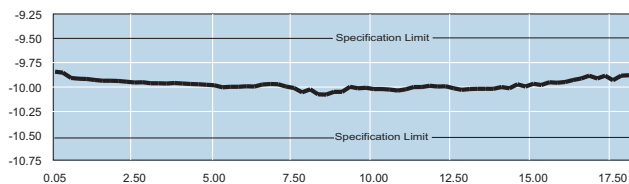

Typical Attenuation Performance of Model 2-10

MAXIMUM SWR:		
Frequency (GHz)	1	2
dc - 4	1.15	1.15
4 - 8	1.20	1.20
8 - 12.4	1.25	1.25
12.4 - 18	---	1.35

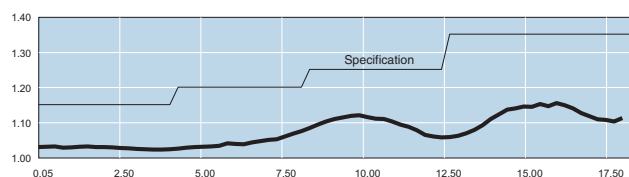

Typical SWR of Model 2-10

POWER RATING: 5 watts **average** to 25°C ambient temperature, derated linearly to 80% @ 45°C, 60% @ 65°C, 40% @ 85°C, 20% @ 105°C, 0 Watts @ 125°C. Note: dB values 1, 2 and 3 can handle 10 watts. 1 kilowatt **peak** (5 μsec pulse width; 0.25% duty cycle).

POWER COEFFICIENT: <0.005 dB/dB/Watt

TEMPERATURE COEFFICIENT: < 0.0004 dB/dB/°C

TEMPERATURE RANGE: -55°C to +125°C

TEST DATA: Insertion Loss and SWR Testing performed across frequency range. Test data available at additional cost.

CONNECTORS: Precision Type N connectors per MIL-STD-348 interface dimensions - mate nondestructively with MIL-C-39012 connectors.

CONSTRUCTION: Stainless steel body and connectors; gold plated beryllium copper contacts.

WEIGHT:

dB VALUE	WEIGHT (Net)
1 - 10, 20, 30	70 g (2.6 oz)
40, 50, 60	100 g (3.6 oz)

PHYSICAL DIMENSIONS:

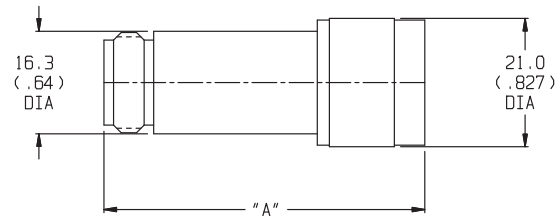

dB VALUE	DIM A
1-10, 20, 30	57.9 (2.28)
40, 50, 60	68.1 (2.68)

NOTE:

1. All dimensions are given in mm (inches) and are maximum, unless otherwise specified.
2. Unit available with RoHS compliant materials, specify when ordering.

MODEL NUMBER DESCRIPTION:

Example:

***1 - XX**

Basic Model Number Attenuation Value (dB)

*Add Prefix M for double male or F for double female connectors.

ATTENUATOR SET (AS-6): Model 2 is also available in a Attenuator Set which includes four different attenuators (3, 6, 10, 20 dB). Refer to Attenuator Sets data sheet for more information.

Fixed Coaxial Attenuators



Model 44 Lab Standard Fixed Coaxial Attenuator

dc to 18.0 GHz
5 Watts

Lab Standard N Connectors



Features

- /// Precision Connectors
- /// Test data - A certificate of test supplied with each attenuator.
- /// Hex Nut Connector - Allows for use of a torque wrench to improve connector repeatability.
- /// Designed to meet environmental requirements of MIL-DTL-3933.

Specifications

NOMINAL IMPEDANCE: 50 Ω

FREQUENCY RANGE: dc to 18.0 GHz

MAXIMUM DEVIATION OVER FREQUENCY:

Nominal ATTN (dB)	Deviation (dB)
1 - 9	± 0.30
10, 20	± 0.50
30, 40	± 1.00
50	± 1.25
60	± 1.50

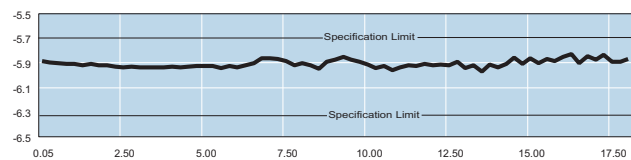

Typical Attenuation Accuracy of a 44-6

MAXIMUM SWR:

Frequency (GHz)	SWR
dc - 4	1.15
4 - 12.4	1.20
12.4 - 18	1.25

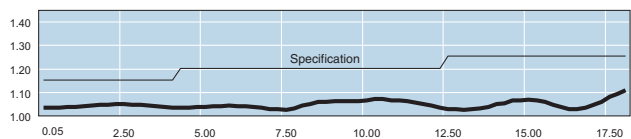

Typical SWR of a 44-6

POWER RATING: 5 watts **average** to 25°C ambient temperature, derated linearly to 4 watts @ 45°C, 3 watts @ 65°C, and 2 watts @ 85 °C. 1 kilowatt **peak** (5 μsec pulse width; 0.25% duty cycle).

POWER COEFFICIENT: < 0.005 dB/dB/watt

TEMPERATURE COEFFICIENT: < 0.0004 dB/dB/°C

TEMPERATURE RANGE: -50°C to +85°C

TEST DATA: Insertion loss and SWR data supplied at 0.05, 4, 8, 12 and 18 GHz. Other test data available at additional cost.

CONNECTORS: Precision Type N per MIL-STD-348 interface dimensions - mate nondestructively with MIL-C-39012 connectors. Coupling Torque: 14 ± 1 in/lbs.

CONSTRUCTION: Brass Body (plated) and Stainless steel connectors; gold plated beryllium copper contacts.

WEIGHT:

dB VALUE	WEIGHT (Net)
1 - 10, 20, 30	100 g (3.5 oz)
40, 50, 60	140 g (4.5 oz)

PHYSICAL DIMENSIONS:

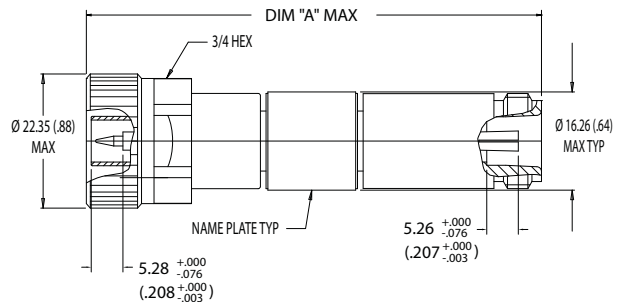

dB VALUE	Prefix M	DIM A STD	Prefix F
0-10, 20, 30	76.2 (3.0)	76.2 (3.0)	77.7 (3.06)
40, 50, 60	86.4 (3.4)	86.4 (3.4)	87.9 (3.46)

NOTE: All dimensions are given in mm (inches) and are maximum, unless otherwise specified.

MODEL NUMBER DESCRIPTION:

Example:

***44 - XX**

Basic Model Number Attenuation Value (dB)

*Add Prefix M for double male or F for double female connectors.

ATTENUATOR SET (AS-18): Model 44 is also available in a Attenuator Set which includes six different attenuators (1, 3, 6, 10, 20, 30 dB). Refer to Attenuator Sets data sheet for more information.

Model 69A Medium Power Fixed Coaxial Attenuator

dc to 18.0 GHz
5 Watts

SMA Connectors, Bi-directional Design



Features

- /// Compact Construction - Lowest size/power ratio.
- /// Precision Injection Molded Connectors.
- /// Designed to meet environmental requirements of MIL-DTL-3933.
- /// Flat Response & Low SWR.

Specifications

NOMINAL IMPEDANCE: 50 Ω
FREQUENCY RANGE: dc to 18.0 GHz

MAXIMUM DEVIATION OVER FREQUENCY:	
Nominal ATTN (dB)	Deviation (dB)
1 - 6	± 0.30
7 - 10, 20, 30	± 0.50

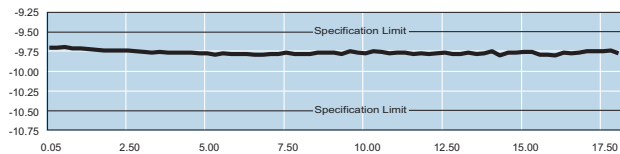

Typical Attenuation Accuracy of a 69A-10

MAXIMUM SWR:	
Frequency (GHz)	SWR
dc - 8	1.15
8 - 18	1.25

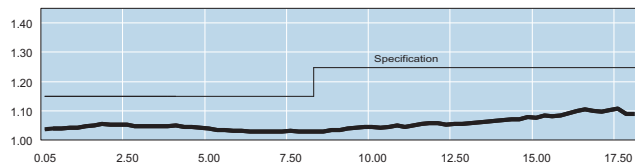

Typical SWR of a 69A-10

POWER RATING (mounted horizontally): 5 watts average (bi-directional) to 25°C ambient temperature, derated linearly to 0.5 Watt @ 125°C. 500 watts peak (5 μsec pulse width; 0.5% duty cycle).

POWER COEFFICIENT: <0.003 dB/dB/watt

TEMPERATURE COEFFICIENT: <0.0004 dB/dB/°C

TEMPERATURE RANGE: -55 °C to 100 °C

TEST DATA: Insertion Loss and SWR Testing performed across frequency range. Test data available at additional cost.

CONNECTORS: SMA connectors per MIL-STD-348 interface dimensions - mate nondestructively with SMK, 3.5mm, 2.92mm and SMA connectors per MIL-C-39012 .

Connector Options	Type/Description
1	SMA, Female
2	SMA, Male

CONSTRUCTION: Black, finned aluminum body, stainless steel connectors; gold plated beryllium copper contacts.

WEIGHT: Net 10 g (0.35 oz) maximum

PHYSICAL DIMENSIONS:

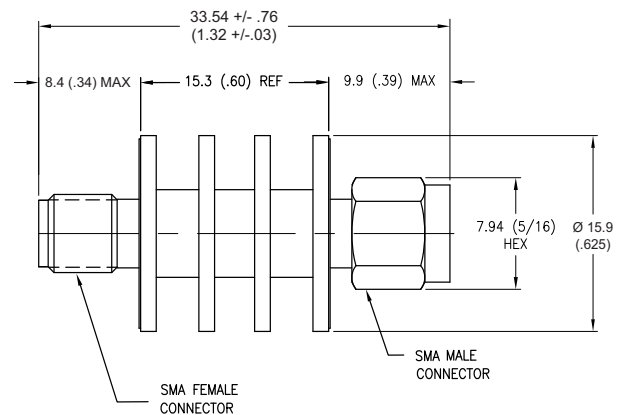

NOTE:

1. All dimensions are given in mm (inches) and are maximum, unless otherwise specified.
2. Unit available with RoHS compliant materials, specify when ordering.

MODEL NUMBER DESCRIPTION:

Example:

69A - XX - 12*

Basic Model Number

Attenuation Value (dB)

Connector Options
-11 Female/Female
-12 Male/Female
-22 Male/Male

*Unit is bi-directional and full power may be applied to either connector.

Fixed Coaxial Attenuators



Model 75A Medium Power Fixed Coaxial Attenuator

dc to 42.0 GHz
5 Watts

Bi-directional Design



Features

- /// **Compact Construction** - Lowest size/power ratio.
- /// **Precision injection molded connector dielectric.**
- /// **Designed to meet environmental requirements of MIL-DTL-3933.**
- /// **Flat Response.**

Specifications

NOMINAL IMPEDANCE: 50 Ω

FREQUENCY RANGE: dc to 42.0 GHz

MAXIMUM DEVIATION OVER FREQUENCY:		
Nominal ATTN (dB)	Deviation (dB)	
	dc-26.5 GHz	26.5-40 GHz
3	± 0.50	± 1.00
6, 10, 20, 30	± 0.80	± 1.50

MAXIMUM SWR:	
Frequency (GHz)	SWR
dc - 26.5	1.25
26.5 - 42	1.45

POWER RATING (mounted horizontally): 5 watts **average (bi-directional)** to 25°C ambient temperature, derated linearly to 0.5 Watt @ 125°C. 200 watts **peak** (5 μsec pulse width; 1.25% duty cycle).

POWER COEFFICIENT: <0.002 dB/dB/watt

TEMPERATURE COEFFICIENT: <0.0004 dB/dB/°C

TEMPERATURE RANGE: -55 °C to 125 °C

TEST DATA SUPPLIED: Sweep SWR/Attenuation data/plots performed across 0.1-40 GHz frequency range.

CONNECTORS: 2.92mm (Male/Female) connectors - mate nondestructively with SMA per MIL-C-39012, 3.5mm and other 2.92mm connectors.

Connector Options	Type/Description
1	2.92mm, Female
2	2.92mm, Male

CONSTRUCTION: Black, finned aluminum body, gold plated beryllium copper contacts.

WEIGHT: 200 g (7.0 oz.) maximum

PHYSICAL DIMENSIONS:

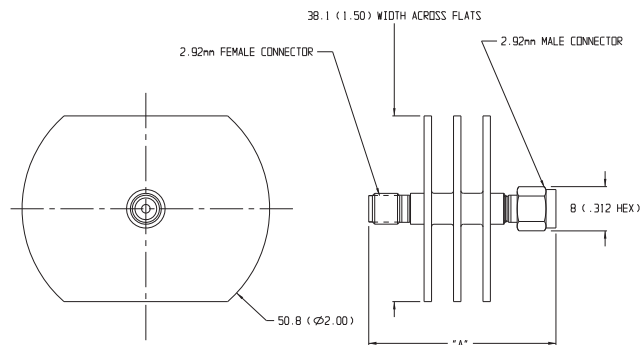

Dash No.	Connector Type	DIM A
11	2.92mm Female/Female	39.9 (1.56)
12	2.92mm Male/Female	44.1 (1.74)
22	2.92mm Male/Male	48.8 (1.92)

NOTE: All dimensions are given in mm (inches) and are nominal, unless otherwise specified.

MODEL NUMBER DESCRIPTION:

Example:

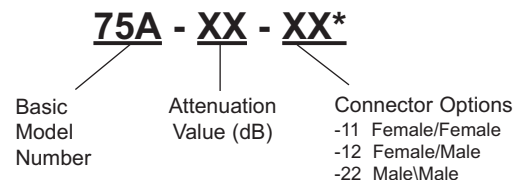

*Unit is bi-directional and full power may be applied to either connector.

Model 41 Medium Power Fixed Coaxial Attenuator

dc to 18.0 GHz
10 Watts

Bi-directional Design

RoHS



Features

- /// **Compact Construction** - Lowest size/power ratio.
- /// **Quality Connectors with special high temperature support beads.**
- /// **Designed to meet environmental requirements of MIL-DTL-3933.**

Specifications

NOMINAL IMPEDANCE: 50 Ω

FREQUENCY RANGE: dc to 18.0 GHz

MAXIMUM DEVIATION OVER FREQUENCY:	
Nominal ATTN (dB)	Deviation (dB)
1, 2	± 0.50
3, 6	± 0.30
10	± 0.50
20	± 0.70
30	± 1.00

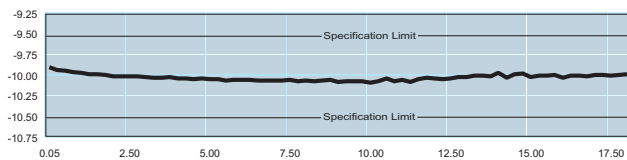

Typical Attenuation Accuracy

MAXIMUM SWR:	
Frequency (GHz)	SWR
dc - 8	1.20
8 - 12.4	1.30
12.4 - 18	1.35

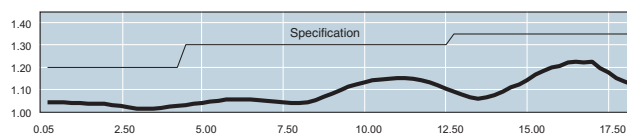

Typical SWR of a 41-10

POWER RATING (mounted horizontally): 10 watts average (bi-directional) to 25°C ambient temperature, derated linearly to 1 Watt @ 125°C. 1 kilowatt **peak** (5 μsec pulse width; 0.5% duty cycle).

POWER COEFFICIENT: <0.0015 dB/dB/watt

TEMPERATURE COEFFICIENT: <0.0004 dB/dB/°C

TEMPERATURE RANGE: -55 °C to 125 °C

TEST DATA: Insertion loss test data supplied at 0.05, 4.0, 8.0, 12.0, and 18.0 GHz. Other test data can be provided at additional cost.

CONNECTORS: SMA (Male/Female) connectors per MIL-STD-348 interface dimensions - mate nondestructively with MIL-C-39012 connectors.

Connector Options	Type/Description
1	SMA, Female
2	SMA, Male

CONSTRUCTION: Black, finned aluminum body, gold plated beryllium copper contacts.

WEIGHT: 28 g (1 oz.) maximum

PHYSICAL DIMENSIONS:

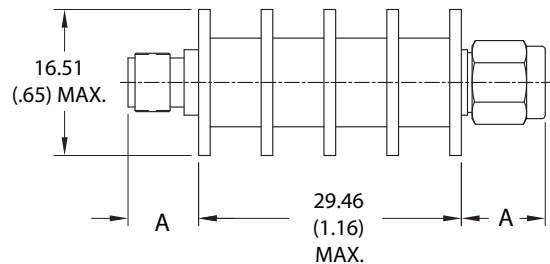

Connector	DIM A
SMA Male	11.18 (0.44)
SMA Female	9.4 (0.37)

NOTE:

1. All dimensions are given in mm (inches) and are maximum, unless otherwise specified.
2. Unit available with RoHS compliant materials, specify when ordering.

MODEL NUMBER DESCRIPTION:

Example:

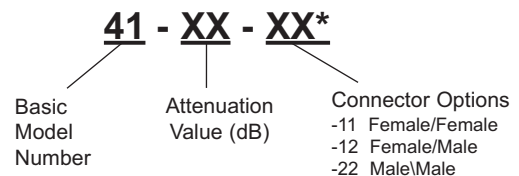

* Unit is bi-directional and full power may be applied to either connector.

Fixed Coaxial Attenuators



Model 37 Medium Power Fixed Coaxial Attenuator

dc to 8.5 GHz
10 Watts

Bi-directional Design!



Features

- /// Optimized for Wireless OEM & Test Applications.
- /// Precision injection molded connector dielectric.
- /// Designed to meet environmental requirements of MIL-DTL-3933.

Specifications

NOMINAL IMPEDANCE: 50 Ω

FREQUENCY RANGE: dc to 8.5 GHz

MAXIMUM DEVIATION OVER FREQUENCY:		
Nominal ATTN (dB)	Deviation (dB)	
	dc-4 GHz	4 - 8.5 GHz
3, 6, 10, 20	± 0.30	± 0.50
30	± 0.50	± 0.80

MAXIMUM SWR:	
Frequency (GHz)	SWR
dc - 4	1.15
4 - 8.5	1.25

POWER RATING (mounted horizontally): 10 watts **average (bi-directional)** to 25°C ambient temperature, derated linearly to 1 watts @ 125°C. Note: 3 dB model can handle 20 Watts **average (bi-directional)**. 1 kilowatt **peak** (5 μsec pulse width; 0.5% duty cycle).

POWER COEFFICIENT: <0.005 dB/dB/watt

TEMPERATURE COEFFICIENT: <0.0004 dB/dB/°C

TEMPERATURE RANGE: -55 °C to 125 °C

TEST DATA: Insertion loss test data supplied at 0.05, 2.0, 4.0, 8.0 and 8.5 GHz. Other test data can be provided at additional cost.

CONNECTORS: Type N connectors per MIL-STD-348 interface dimensions - mate nondestructively with MIL-C-39012 connectors.

Connector Options	Type/Description
3	Type N, Female
4	Type N, Male

CONSTRUCTION: Black, finned aluminum body, gold plated beryllium copper contacts.

WEIGHT: 110 g (4 oz.) maximum

PHYSICAL DIMENSIONS:

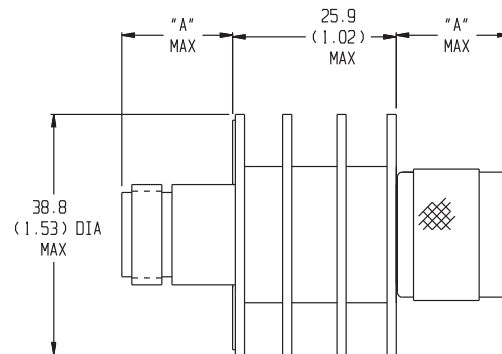

Connector	DIM A
N Male	24.1 (0.95)
N Female	19.1 (0.75)

NOTE:

1. All dimensions are given in mm (inches) and are maximum, unless otherwise specified.
2. Unit available with RoHS compliant materials, specify when ordering.

MODEL NUMBER DESCRIPTION:

Example:

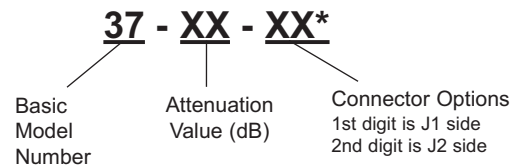

*Unit is bi-directional and full power may be applied to either J1 or J2.

Model 23 Medium Power Fixed Coaxial Attenuator

dc to 18.0 GHz
10 Watts

Bi-directional Design!

RoHS



Features

- /// Precision injection molded connector dielectric.
- /// Designed to meet environmental requirements of MIL-DTL-3933.

Specifications

NOMINAL IMPEDANCE: 50 Ω

FREQUENCY RANGE: dc to 18.0 GHz

MAXIMUM DEVIATION OVER FREQUENCY:	
Nominal ATTN (dB)	Deviation (dB)
1, 2	± 0.50
3, 6	± 0.30
10, 20	± 0.50
30, 40	± 1.00
50	± 1.25
60	± 1.50

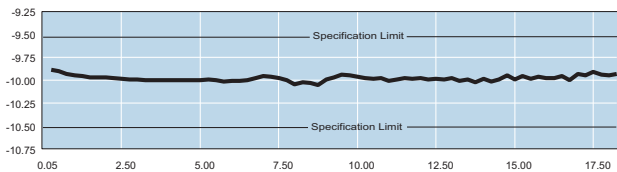

Typical Attenuation Accuracy of a 23-10-34

MAXIMUM SWR:	
Frequency (GHz)	SWR
dc - 4	1.15
4 - 8	1.20
8 - 12.4	1.25
12.4 - 18	1.35

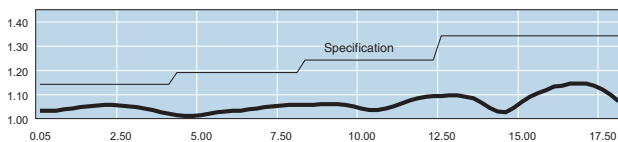

Typical SWR of a 23-10-34

POWER RATING (mounted horizontally): 10 watts average (bi-directional) to 25°C ambient temperature, derated linearly to 1 watts @ 125°C. Note: 1, 2, 3 dB models can handle 20 Watts average (bi-directional). 1 kilowatt peak (5 μsec pulse width; 0.5% duty cycle).

POWER COEFFICIENT: <0.0015 dB/dB/watt

TEMPERATURE COEFFICIENT: <0.0004 dB/dB/°C

TEMPERATURE RANGE: -55°C to 125°C

TEST DATA: Insertion loss test data supplied at 0.05, 4.0, 8.0, 12.0, and 18.0 GHz. Other test data can be provided at additional cost.

CONNECTORS: Type N connectors per MIL-STD-348 interface dimensions - mate nondestructively with MIL-C-39012 connectors.

Connector Options	Type/Description
3	Type N, Female
4	Type N, Male

CONSTRUCTION: Black, finned aluminum body, gold plated beryllium copper contacts.

WEIGHT: 110 g (4 oz.) maximum

PHYSICAL DIMENSIONS:

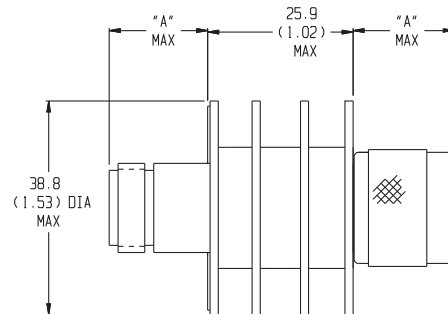

Connector	DIM A
N Male	24.1 (0.95)
N Female	19.1 (0.75)

NOTE:

1. All dimensions are given in mm (inches) and are maximum, unless otherwise specified.
2. Unit available with RoHS compliant materials, specify when ordering.

MODEL NUMBER DESCRIPTION:

Example:

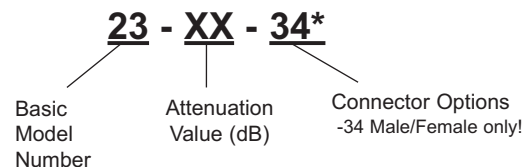

* Unit is bi-directional and full power may be applied to either J1 or J2.

Fixed Coaxial Attenuators



Model 89 Medium Power Fixed Coaxial Attenuator

dc to 40.0 GHz
20 Watts

Higher Power Vs Frequency Design



Features

- /// Compact Construction - Lowest size/power ratio.
- /// Precision injection molded connector dielectric.
- /// Designed to meet environmental requirements of MIL-DTL-3933.
- /// Flat Response.

Specifications

NOMINAL IMPEDANCE: 50 Ω

FREQUENCY RANGE: dc to 40.0 GHz

MAXIMUM DEVIATION OVER FREQUENCY:

Nominal ATTN (dB)	Deviation (dB)	
	dc-18 GHz	18-40 GHz
10, 20, 30	± 1.5	+3.0/-0.0

MAXIMUM SWR:

Frequency (GHz)	SWR
dc - 18	1.25
18 - 40	1.40

POWER RATING (mounted horizontally): 20 watts **average (unidirectional)** to 25°C ambient temperature, derated linearly to 2 Watts @ 125°C. 200 watts **peak** (5 μsec pulse width; 1.25% duty cycle). Maximum in power into output port is 5 Watts.

POWER COEFFICIENT: <0.002 dB/dB/watt

TEMPERATURE COEFFICIENT: <0.0004 dB/dB/°C

TEMPERATURE RANGE: -55 °C to 125 °C

TEST DATA SUPPLIED: Sweep SWR/Attenuation data/plots performed across 0.1-40 GHz frequency range.

CONNECTORS: 2.92mm (Male/Female) connectors - mate nondestructively with SMA per MIL-C-39012, 3.5mm and other 2.92mm connectors.

Connector Options	Type/Description
1	2.92mm, Female
2	2.92mm, Male

CONSTRUCTION: Black, finned aluminum body, gold plated beryllium copper contacts.

WEIGHT: 200 g (8.0 oz.) maximum

PHYSICAL DIMENSIONS:

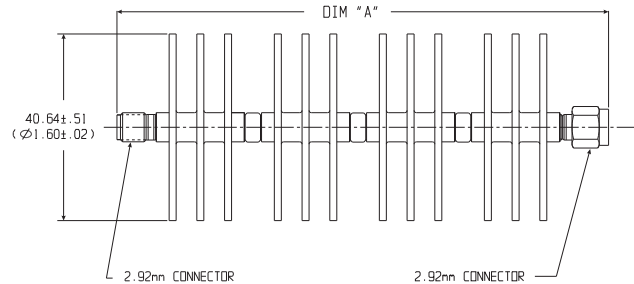

Dash No.	Connector Type	DIM A
11	2.92mm Female/Female	106.2 (4.18)
12	2.92mm Female/Male	109.2 (4.30)
21	2.92mm Male/Female	109.2 (4.30)
22	2.92mm Male/Male	112.0 (4.40)

NOTE: All dimensions are given in mm (inches) and are nominal, unless otherwise specified.

MODEL NUMBER DESCRIPTION:

Example:

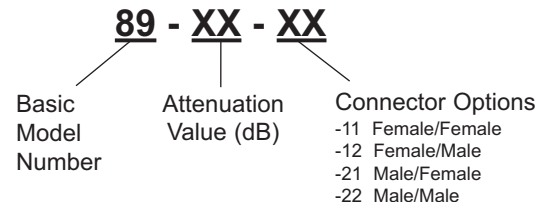

Model 34 Medium Power Fixed Coaxial Attenuator

dc to 4.0 GHz
25 Watts

Bi-directional Design



Features

- /// Optimized for Wireless OEM & Test Applications.
- /// Precision Connectors with high temperature support beads.
- /// Designed to meet environmental requirements of MIL-DTL-3933.

Specifications

NOMINAL IMPEDANCE: 50 Ω

FREQUENCY RANGE: dc to 4.0 GHz

MAXIMUM DEVIATION OVER FREQUENCY:

Nominal ATTN (dB)	Deviation (dB)	
	dc-2 GHz	2 - 4 GHz
3, 6, 10, 20, 30	± 0.60	± 1.00

MAXIMUM SWR*:

Frequency (GHz)	SWR
dc - 2	1.10
2 - 4	1.20

POWER RATING (mounted horizontally): 25 watts **average (bi-directional)** to 25°C ambient temperature, derated linearly to 2.5 watts @ 125°C. Note: 3 dB model can handle 50 Watts **average (bi-directional)**. 5 kilowatt **peak** (5 μsec pulse width; 0.5% duty cycle).

POWER COEFFICIENT: <0.0006 dB/dB/watt

TEMPERATURE COEFFICIENT: <0.0004 dB/dB/°C

TEMPERATURE RANGE: -55 °C to 125 °C

TEST DATA: Insertion loss test data supplied at 0.05, and 4.0 GHz. Other test data can be provided at additional cost.

CONNECTORS: Type N connectors per MIL-STD-348 interface dimensions - mate nondestructively with MIL-C-39012 connectors.

Connector Options	Type/Description
3	Type N, Female
4	Type N, Male

CONSTRUCTION: Black, finned aluminum body, gold plated beryllium copper contacts.

WEIGHT: 170 g (6 oz.) maximum

PHYSICAL DIMENSIONS:

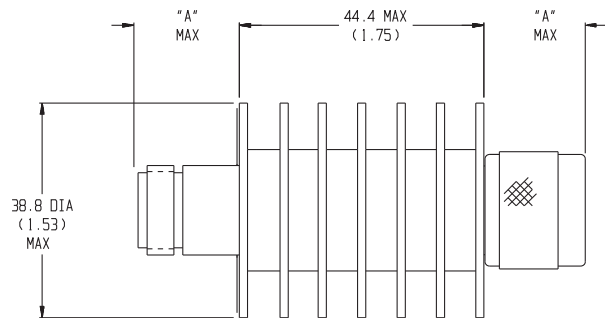

Connector	DIM A
N Male	22.9 (0.90)
N Female	15.0 (0.59)

NOTE:

1. All dimensions are given in mm (inches) and are maximum, unless otherwise specified.
2. Unit available with RoHS compliant materials, specify when ordering.

MODEL NUMBER DESCRIPTION:

Example:

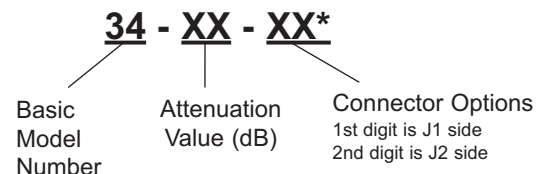

*Unit is bi-directional and full power may be applied to either J1 or J2.

Fixed Coaxial Attenuators



Model 33 Medium Power Fixed Coaxial Attenuator

dc to 8.5 GHz
25 Watts

Bi-directional Design!



Features

- Quality Connectors with special high temperature support beads.
- Designed to meet environmental requirements of MIL-DTL-3933.
- Low Intermodulation option available.
- Mode free operation to 10 GHz.

Specifications

NOMINAL IMPEDANCE: 50 Ω

FREQUENCY RANGE: dc to 8.5 GHz

MAXIMUM DEVIATION OVER FREQUENCY (dB):				
Nominal ATTN (dB)	dc-4 GHz		4 - 8.5 GHz	
	33	33-LIM	33	33-LIM
3, 6	± 0.30	---	± 0.60	---
10, 20	± 0.30	± 0.40	± 0.60	± 0.70
30	± 0.60	± 0.70	± 1.00	± 1.20

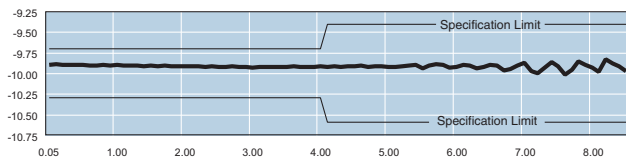

Typical Attenuation Accuracy of a 33-10-34

MAXIMUM SWR:	
Frequency (GHz)	SWR
dc - 4	1.20
4 - 8.5	1.30

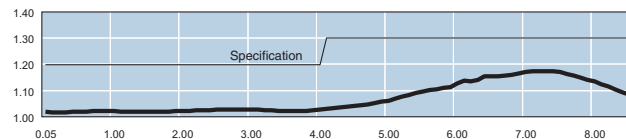

Typical SWR of a 33-10-34

3rd ORDER INTERMODULATION (33-XX-XX-LIM Only): Reflected Levels (IM3), -100 dBc and Through Levels (IM3), -110 dBc with two input signals @ 869 MHz and 891 MHz with average carrier power levels of +41 dBm each. IM specification at J2 limited to 10 Watts of input power.

POWER RATING (mounted horizontally): 25 watts average (bi-directional) to 25°C ambient temperature, derated linearly to 2.5 watts @ 125°C. Note: 3 dB model can handle 50 Watts average (bi-directional). 5 kilowatt peak (5 μsec pulse width; 0.25% duty cycle).

POWER COEFFICIENT: <0.0006 dB/dB/watt

TEMPERATURE COEFFICIENT: <0.0004 dB/dB/°C

TEMPERATURE RANGE: -55 °C to 125 °C

TEST DATA: Insertion loss test data supplied at 0.05, 4.0, and 8.5 GHz. Other test data can be provided at additional cost.

CONNECTORS: Type N & 2.92mm connectors per MIL-STD-348 interface dimensions - mate nondestructively with MIL-C-39012 connectors.

Options	Description	Options	Description
1	2.92mm Female	3	Type N, Female
2	2.92mm Male	4	Type N, Male

CONSTRUCTION: Black, finned aluminum body, gold plated beryllium copper contacts.

WEIGHT: 170 g (6 oz.) maximum

PHYSICAL DIMENSIONS:

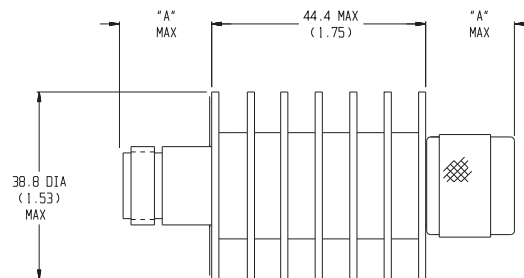

Connector	DIM A	Connector	DIM A
N Male	22.9 (0.90)	2.92mm Female	14.0 (0.55)
N Female	15.0 (0.59)	2.92mm Male	

NOTE:

- All dimensions are given in mm (inches) and are maximum, unless otherwise specified.
- Unit available with RoHS compliant materials, specify when ordering.

MODEL NUMBER DESCRIPTION:

Example:

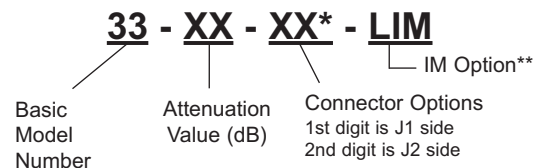

*Unit is bi-directional & full power may be applied to either J1 or J2.

**Add -LIM to entire model number for Low Intermodulation option.

Available in only 10, 20, 30 dB and is not available through Express.

Model 46 Medium Power Fixed Coaxial Attenuator

dc to 18.0 GHz
25 Watts

Bi-directional Design!

RoHS



Features

- Designed to meet environmental requirements of MIL-DTL-3933.
- Rugged injection molded connector dielectric.
- Low Intermodulation option available.

Specifications

NOMINAL IMPEDANCE: 50 Ω

FREQUENCY RANGE: dc to 18.0 GHz

MAXIMUM DEVIATION OVER FREQUENCY:			
Nominal ATTN (dB)	46	46 LIM	
		dc - 8 GHz	8- 18 GHz
3, 6	± 0.50	---	---
10	± 0.50	± 1.00	+2.0/-1.0
20	± 0.75	± 1.00	+2.0/-1.0
30, 40	± 1.00	± 1.00	+2.0/-1.0

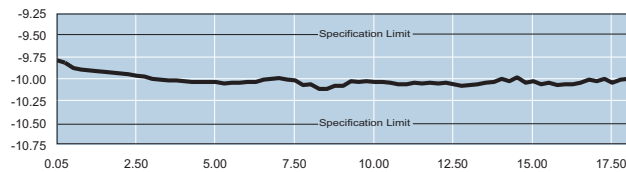

Typical Attenuation Accuracy of a 46-10-34

MAXIMUM SWR:	
Frequency (GHz)	SWR
dc - 8	1.20
8 - 12.4	1.25
12.4 - 18	1.35

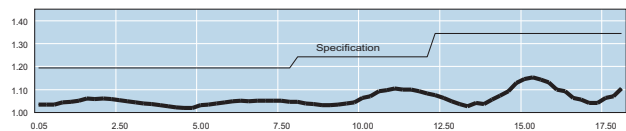

Typical SWR of a 46-10-34

3rd ORDER INTERMODULATION (46-XX-XX-LIM ONLY): Reflected Levels (IM3), -90 dBc and Through Levels (IM3), -100 dBc with two input signals @ 869 MHz and 891 MHz with average carrier power levels of +41 dBm each. Option only available 10, 20, 30, 40 dB.

POWER RATING (mounted horizontally): 25 watts average (bi-directional) to 25°C ambient temperature, derated linearly to 2.5 watts @ 125°C. Note: 3 dB model can handle 50 Watts average (bi-directional). 1 kilowatt peak (5 μsec pulse width; 1.25% duty cycle).

POWER COEFFICIENT: <0.0006 dB/dB/watt

TEMPERATURE COEFFICIENT: <0.0004 dB/dB/°C

TEMPERATURE RANGE: -55°C to 125°C

TEST DATA: Insertion loss test data supplied at 0.05, 4.0, 8.0, 12.0, and 18.0 GHz. Other test data can be provided at additional cost.

CONNECTORS: Type N connectors per MIL-STD-348 interface dimensions - mate nondestructively with MIL-C-39012 connectors.

3.5mm Connectors - mate nondestructively with SMA per MIL-C-39012, 2.92mm and other 3.5mm connectors.

Options	Description	Options	Description
1	3.5mm Female	3	Type N Female
2	3.5mm Male	4	Type N Male

CONSTRUCTION: Black, finned aluminum body, stainless steel connectors with gold plated beryllium copper contacts.

WEIGHT: 110 g (4 oz.) maximum

PHYSICAL DIMENSIONS:

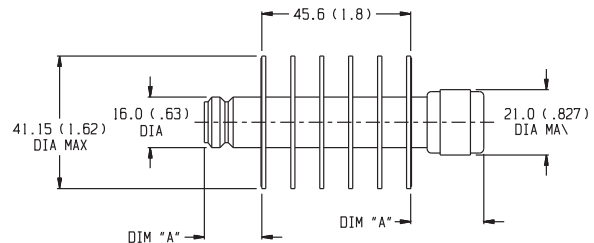

Connector	DIM A	Connector	DIM A
N Male	24.1 (0.95)	3.5mm Female	14.0 (0.55)
N Female	19.0 (0.75)	3.5mm Male	13.2 (0.52)

NOTE:

- All dimensions are given in mm (inches) and are maximum, unless otherwise specified.
- Unit available with RoHS compliant materials, specify when ordering.

MODEL NUMBER DESCRIPTION:

Example:

46 - XX - XX* - LIM

Basic Model Number Attenuation Value (dB) Connector Options
1st digit is J1 side 2nd digit is J2 side

* Unit is bi-directional & full power may be applied to either J1 or J2.

** Add -LIM for Low Intermodulation option. Option only available in 10, 20, 30 and 40 dB and is not available through Express.

Fixed Coaxial Attenuators



Model 74 Medium Power Fixed Coaxial Attenuator

dc to 28.0 GHz
25 Watts

3.5mm Connectors



TEST DATA SUPPLIED: Sweep SWR/Attenuation data/plots performed across 0.1-26.5 GHz frequency range.

CONNECTORS: 3.5mm (Male/Female) connectors - mate nondestructively with SMA per MIL-C-39012, 2.92mm and other 3.5mm connectors.

Connector Options	Type/Description
1	3.5mm, Female
2	3.5mm, Male

CONSTRUCTION: Black, finned aluminum body, gold plated beryllium copper contacts.

WEIGHT: 100 g (3.5 oz.) maximum

PHYSICAL DIMENSIONS:

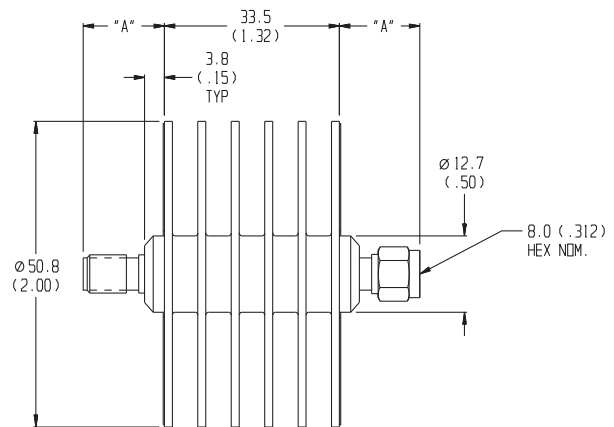

Connector	DIM A
3.5mm Male	16.0 (0.63)
3.5mm Female	15.0 (0.59)

NOTE: All dimensions are given in mm (inches) and are maximum, unless otherwise specified.

Features

- /// Compact Construction - Lowest size/power ratio.
- /// Precision injection molded connector dielectric.
- /// Designed to meet environmental requirements of MIL-DTL-3933.
- /// Low SWR Design.

Specifications

NOMINAL IMPEDANCE: 50 Ω

FREQUENCY RANGE: dc to 28 GHz

MAXIMUM DEVIATION OVER FREQUENCY:	
Nominal ATTN (dB)	Deviation (dB)
3	± 0.70
6, 10	± 1.00
20, 30	± 1.50

MAXIMUM SWR:	
Frequency (GHz)	SWR
dc - 18	1.30
18 - 28	1.35

POWER RATING: 25 watts **average (unidirectional)** to 25°C ambient temperature, derated linearly to 2.5 Watt @ 125°C. 500 watts **peak** (5 μsec pulse width; 2.5% duty cycle). Maximum power rating into output is 10% of the average power rating.

POWER COEFFICIENT: <0.0015 dB/dB/watt

TEMPERATURE COEFFICIENT: <0.0004 dB/dB/°C

TEMPERATURE RANGE: -55°C to 125°C

MODEL NUMBER DESCRIPTION:

Example:

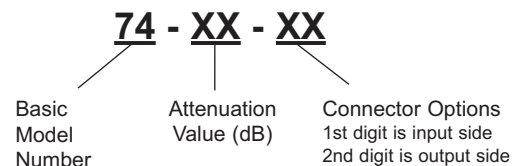

Model 72 Medium Power Fixed Coaxial Attenuator

dc to 4.0 GHz
50 Watts

Conduction Cooled



Features

- /// **Compact Construction** - Lowest size/power ratio.
- /// **Precision Connectors with high temperature support beads.**
- /// **Designed to meet environmental requirements of MIL-DTL-3933.**
- /// **Wireless Applications** - Optimized for use in the communications bands.

Specifications

NOMINAL IMPEDANCE: 50 Ω
FREQUENCY RANGE: dc to 4.0 GHz

MAXIMUM DEVIATION OVER FREQUENCY:	
Nominal ATTN (dB)	Deviation (dB)
3, 6, 10, 20, 30, 40	± 0.70

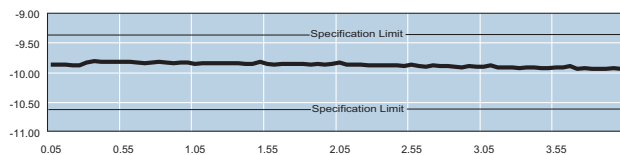

Typical Attenuation Accuracy of a 72-10-34

MAXIMUM SWR:	
Frequency (GHz)	SWR
dc - 4	1.20

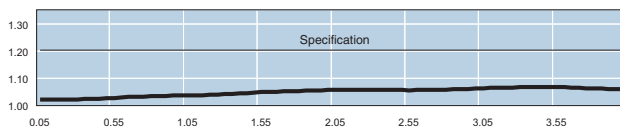

Typical SWR of a 72-10-34

POWER RATING 50 watts **average (unidirectional)**, 5 kilowatts **peak** (5 μsec pulse width; 0.5 % duty cycle) with case temperature held within **100°C maximum** with appropriate conductive heat sink. Maximum power rating into output port is 10% of the average power rating.

POWER COEFFICIENT: <0.0005 dB/dB/watt

TEMPERATURE COEFFICIENT: <0.0004 dB/dB/°C

TEMPERATURE RANGE: -55°C to 100°C (case)

TEST DATA: Insertion Loss and SWR Testing performed across frequency range. Test data available at additional cost.

CONNECTORS: Type N connectors per MIL-STD-348 interface dimensions - mate nondestructively with MIL-C-39012 connectors. 2.92mm connectors mate with SMA, 3.5mm, Type K and other 2.92mm connectors.

Connector Options	Type/Description
1	2.92mm, Female
2	2.92mm, Male
3	Type N, Female
4	Type N, Male

CONSTRUCTION: Aluminum body, stainless steel connectors; gold plated beryllium copper contacts.

WEIGHT: 170 g (6 oz.) maximum

PHYSICAL DIMENSIONS:

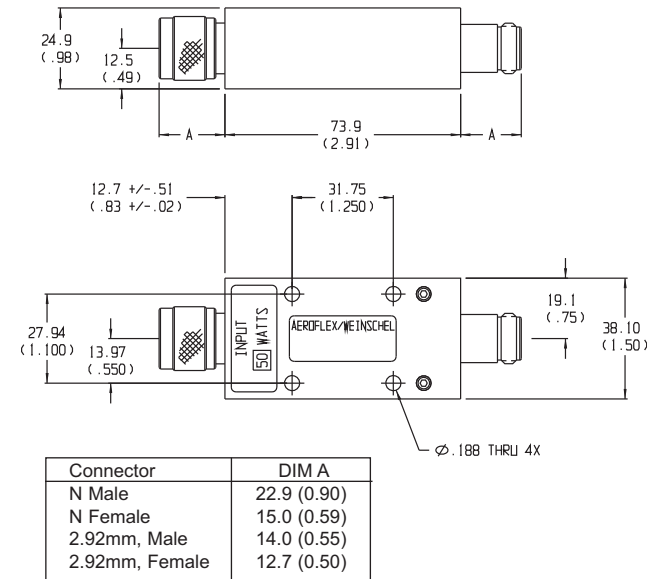

NOTE:

- All dimensions are given in mm (inches) and are maximum, unless otherwise specified.
- Unit available with RoHS compliant materials, specify when ordering.

MODEL NUMBER DESCRIPTION:

Example:

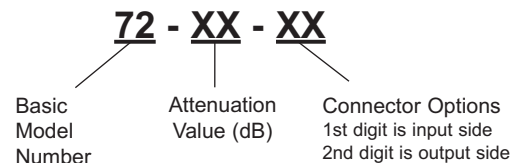

Fixed Coaxial Attenuators



Model 24 Medium Power Fixed Coaxial Attenuator

dc to 8.5 GHz
50 Watts

Bi-Directional Design!



Features

- /// Designed to meet environmental requirements of MIL-DTL-3933.
- /// Low Intermodulation option available.
- /// Mode free operation to 10 GHz.

Specifications

NOMINAL IMPEDANCE: 50 Ω

FREQUENCY RANGE: dc to 8.5 GHz

MAXIMUM DEVIATION OVER FREQUENCY (dB):				
Nominal ATTN (dB)	dc-4 GHz		4 - 8.5 GHz	
	24	24-LIM	24	24-LIM
3, 6	± 0.40	---	± 0.75	---
10, 20	± 0.40	± 0.50	± 0.75	± 1.00
30, 40	± 0.60	± 0.70	± 1.00	± 1.25

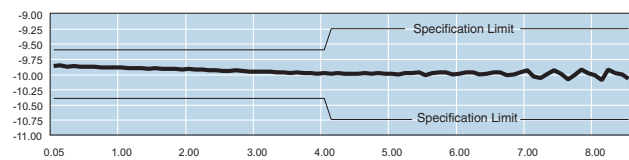

Typical Attenuation Accuracy of a 24-10-34

MAXIMUM SWR:	
Frequency (GHz)	SWR
dc - 4	1.20
4 - 8.5	1.30

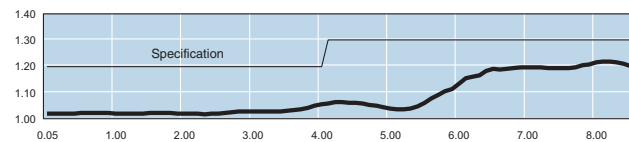

Typical SWR of a 24-10-34

3rd ORDER INTERMODULATION (24-XX-XX-LIM only!): Reflected Levels (IM3), -100 & Through Levels (IM3), -110 dBc with two input signals @ 869 MHz and 891 MHz with average carrier power levels of +43 dBm each. Option only available 10, 20, 30, 40 dB. IM specification at J2 limited to 20 Watts of input power.

POWER RATING (mounted horizontally): 50 watts average (bi-directional) to 25°C ambient temperature, derated linearly to 2.5 watts @ 125°C. Note: 3 dB model can handle 100 Watts average (bi-directional). 5 kilowatt peak (5 μsec pulse width; 0.5% duty cycle).

POWER COEFFICIENT: <0.0003 dB/dB/watt

TEMPERATURE COEFFICIENT: <0.0004 dB/dB/°C

TEMPERATURE RANGE: -55°C to 125°C

TEST DATA: Insertion loss test data supplied at 0.05, 4.0, and 8.5 GHz. Other test data can be provided at additional cost.

CONNECTORS: Type N connectors per MIL-STD-348 interface dimensions - mate nondestructively with MIL-C-39012 connectors. 2.92mm connectors - mate nondestructively with SMA per MIL-C-39012, 3.5mm, SMK, and other 2.92mm. Female 2.92mm connector NOT RoHS compliant.

Options	Description	Options	Description
1	2.92mm, Female	3	Type N, Female
2	2.92mm, Male	4	Type N, Male

CONSTRUCTION: Black, finned aluminum body, gold plated beryllium copper contacts.

WEIGHT: 280 g (10 oz.) maximum

PHYSICAL DIMENSIONS:

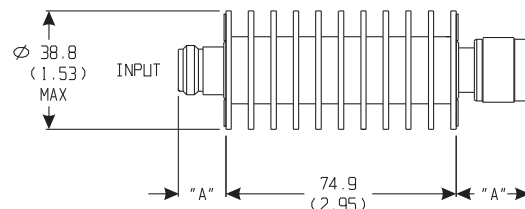

Connector	DIM A	Connector	DIM A
N Male	22.9 (0.90)	2.92mm Male	14.0 (0.55)
N Female	15.0 (0.59)	2.92mm Female	12.7 (0.50)

NOTE:

1. All dimensions are given in mm (inches) and are maximum, unless otherwise specified.
2. Unit available with RoHS compliant materials, specify when ordering.

MODEL NUMBER DESCRIPTION:

Example:

24 - XX - XX* - LIM

Basic Model Number Attenuation Value (dB) Connector Options
 1st digit is J1 side
 2nd digit is J2 side

*Unit is bi-directional & full power may be applied to either J1 or J2.

**Add -LIM to entire model number for Low Intermodulation option. Option only available in 10, 20, 30, 40 dB and is not available through Express.

Model 90 Medium Power Fixed Coaxial Attenuator

dc to 18.0 GHz
50 Watts

Bi-directional Design!



Features

- /// Precision injection molded connector dielectric.
- /// Designed to meet environmental requirements of MIL-DTL-3933.
- /// Flat Response.

Specifications

NOMINAL IMPEDANCE: 50 Ω

FREQUENCY RANGE: dc to 18.0 GHz

MAXIMUM DEVIATION OVER FREQUENCY:

Nominal ATTN (dB)	Deviation (dB)
3, 6	± 0.50
10, 20	± 0.75
30	± 1.00

MAXIMUM SWR:

Frequency (GHz)	SWR
dc - 8	1.15
8 - 12.4	1.20
12.4 - 18	1.30

POWER RATING (mounted horizontally): 50 watts average (bi-directional) to 25°C ambient temperature, derated linearly to 10 Watts @ 125°C. 1 kW peak (5 μsec pulse width; 2.5% duty cycle).

POWER COEFFICIENT: <0.0006 dB/dB/watt

TEMPERATURE COEFFICIENT: <0.0004 dB/dB/°C

TEMPERATURE RANGE: -55 °C to 125 °C

TEST DATA SUPPLIED: Sweep SWR/Attenuation data/plots performed across 50 MHz to 18 GHz frequency range. Frequency Markers 0.05, 2.0, 4.0 8.0, 12.4, 18 GHz.

CONNECTORS: Type N (Male/Female) connectors - mate nondestructively with other N connectors per MIL-C-39012.

Connector Options	Type/Description
3	N, Female
4	N, Male

CONSTRUCTION: Black, finned aluminum body, gold plated beryllium copper contacts.

WEIGHT: 120 g (4.2 oz.) maximum

PHYSICAL DIMENSIONS:

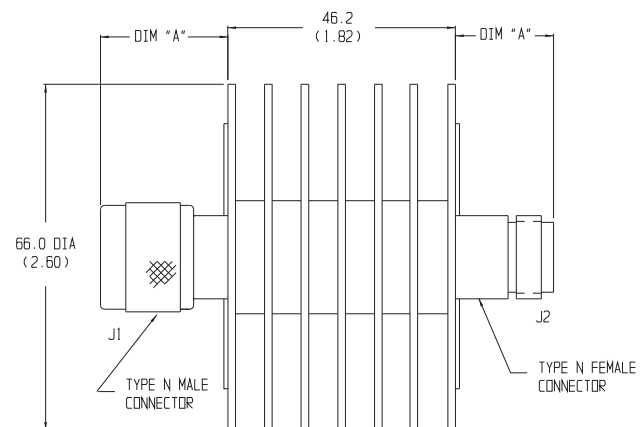

Connector	DIM A
N Male	24.1 (0.95)
N Female	19.0 (0.75)

NOTE:

1. All dimensions are given in mm (inches) and are maximum, unless otherwise specified.
2. Unit available with RoHS compliant materials, specify when ordering.

MODEL NUMBER DESCRIPTION:

Example:

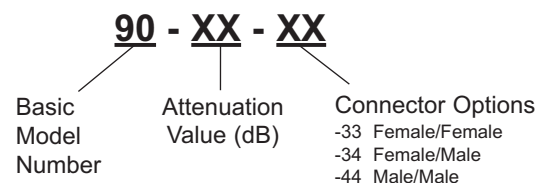

Fixed Coaxial Attenuators



Model 47 Medium Power Fixed Coaxial Attenuator

dc to 18.0 GHz
50 Watts

Type N Connectors



Features

- Designed to meet environmental requirements of MIL-DTL-3933.
- Low Intermodulation option available.
- Rugged injection molded connector dielectric.

Specifications

NOMINAL IMPEDANCE: 50 Ω

FREQUENCY RANGE: dc to 18.0 GHz

MAXIMUM DEVIATION OVER FREQUENCY:

Nominal ATTN (dB)	47	47 LIM	
		dc-8 GHz	8-18 GHz
3, 6	± 0.75	---	---
10, 20	± 0.75	± 0.75	+2.0/-0.5
30, 40	± 1.00	± 0.75	+2.0/-0.5

MAXIMUM SWR:

Frequency (GHz)	3, 6 dB	10, 20, 30, 40 dB
dc - 8	1.25	1.20
8 - 12.4	1.35	1.25
12.4 - 18	1.45	1.35

3rd ORDER INTERMODULATION (47-XX-XX-LIM ONLY): Reflected Levels (IM3), -90 & Through Levels (IM3), -100 dBc with two input signals @ 869 MHz and 891 MHz with average carrier power levels of +43 dBm each. Option only available 10, 20, 30, 40 dB.

POWER RATING (mounted horizontally): 50 watts average (unidirectional) to 25°C ambient temperature, derated linearly to 5 watts @ 125°C. Note: 3 dB model can handle 100 Watts average (unidirectional). 1 kilowatt peak (5 μsec pulse width; 2.5% duty cycle). Maximum power rating into output port is 10 Watts average.

POWER COEFFICIENT: <0.0003 dB/dB/watt

TEMPERATURE COEFFICIENT: <0.0004 dB/dB/°C

TEMPERATURE RANGE: -55°C to 125°C

TEST DATA: Insertion loss test data supplied at 0.05, 4.0, 8.0, 12.0, and 18.0 GHz. Other test data can be provided at additional cost.

CONNECTORS: Type N connectors per MIL-STD-348 interface dimensions - mate nondestructively with MIL-C-39012 connectors.

3.5mm Connectors - mate nondestructively with SMA per MIL-C-39012, 2.92mm and other 3.5mm connectors.

Options	Description	Options	Description
1	3.5mm Female	3	Type N Female
2	3.5mm Male	4	Type N Male

CONSTRUCTION: Black, finned aluminum body, stainless steel connectors with gold plated beryllium copper contacts.

WEIGHT: 175 g (6 oz.) maximum

PHYSICAL DIMENSIONS:

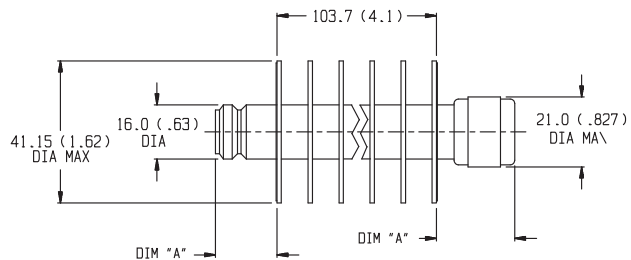

Connector	DIM A	Connector	DIM A
N Male	24.1 (0.95)	3.5mm Female	14.0 (0.55)
N Female	19.0 (0.75)	3.5mm Male	13.2 (0.52)

NOTE:

- All dimensions are given in mm (inches) and are maximum, unless otherwise specified.
- Unit available with RoHS compliant materials, specify when ordering.

MODEL NUMBER DESCRIPTION:

Example:

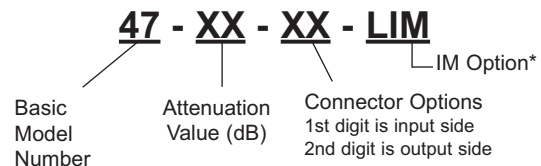

* Add -LIM for Low Intermodulation option. Option only available in 10, 20, 30 and 40 dB and is not available through Express.

Model 86 Medium Power Fixed Coaxial Attenuator

dc to 22.0 GHz
50 Watts

Conduction Cooled, 3.5mm Connectors



CONSTRUCTION: Aluminum body, stainless steel connectors; gold plated beryllium copper contacts.

WEIGHT: 60 g (2.1 oz.) maximum

PHYSICAL DIMENSIONS:

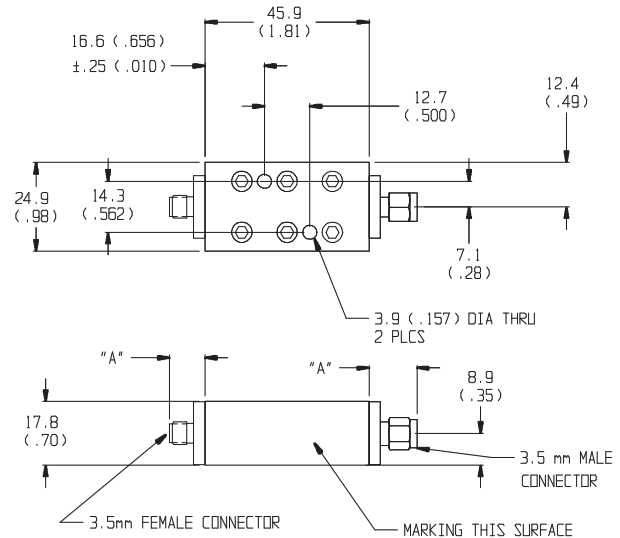

Features

- /// **Compact Construction** - Lowest size/power ratio.
- /// **Precision Connectors** with high temperature support beads.
- /// **Designed to meet environmental requirements of MIL-DTL-3933.**
- /// **Ideal for Airborne or Space Applications.**

Specifications

NOMINAL IMPEDANCE: 50 Ω
FREQUENCY RANGE: dc to 22.0 GHz

MAXIMUM DEVIATION OVER FREQUENCY:

Nominal ATTN (dB)	Deviation (dB)
3, 6, 10, 20, 30	± 0.80

MAXIMUM SWR: 1.30

POWER RATING 50 watts **average (bi-directional)**, 1 kilowatts **peak** (5 μsec pulse width; 0.5 % duty cycle) with case temperature held within **90°C maximum** with appropriate conductive heat sink.

POWER COEFFICIENT: <0.0006 dB/dB/watt

TEMPERATURE COEFFICIENT: <0.0004 dB/dB/°C

TEMPERATURE RANGE: -55°C to 90°C (case)

CONNECTORS: 3.5mm connectors - mate nondestructively with SMA per MIL-C-39012, 2.92mm and other 3.5mm connectors.

Options	Description
1	3.5mm Female
2	3.5mm Male

Connector	DIM A
3.5mm Male	13.4±0.5 (0.53±0.02)
3.5mm Female	9.9±0.5 (0.32±0.02)

NOTE: All dimensions are given in mm (inches) and are nominal, unless otherwise specified.

MODEL NUMBER DESCRIPTION:

Example:

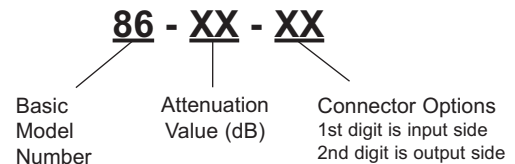

Fixed Coaxial Attenuators



Model 59 High Power Fixed Coaxial Attenuator

dc to 2.5 GHz
100 Watts

Conduction Cooled



Features

- /// Precision Connectors with high temperature support beads.
- /// Designed to meet environmental requirements of MIL-DTL-3933.
- /// 10 Kilowatts peak, Conductive Cooled
- /// Wireless Applications - Optimized for use in the communications bands.

Specifications

NOMINAL IMPEDANCE: 50 Ω

FREQUENCY RANGE: dc to 2.5 GHz

MAXIMUM DEVIATION OVER FREQUENCY:		
Nominal ATTN (dB)	Deviation (dB)	
	dc-1 GHz	1-2.5 GHz
3, 6, 10, 20, 30, 40	± 0.70	± 1.00

MAXIMUM SWR:	
Frequency (GHz)	SWR
dc - 2.5	1.15

POWER RATING 100 watts **average (unidirectional)**, 10 kilowatts **peak** (5 μsec pulse width; 0.4 % duty cycle) with case temperature held within **100 °C maximum** with appropriate conductive heat sink. Note: 3 dB model can handle 200 Watts **average (unidirectional)**. Maximum power rating into output port is 10 % of the average power rating.

POWER COEFFICIENT: <0.0004 dB/dB/watt

TEMPERATURE COEFFICIENT: <0.0003 dB/dB/°C

TEMPERATURE RANGE: -55°C to 100°C (case temp)

TEST DATA: Insertion loss test data supplied at 0.05, 0.5, 1.0, 1.5, 2.0 and 2.5 GHz. Other test data can be provided at additional cost.

CONNECTORS: Type N connectors per MIL-STD-348 interface dimensions - mate nondestructively with MIL-C-39012 connectors.

Connector Options	Type/Description
3	Type N, Female
4	Type N, Male

CONSTRUCTION: Aluminum alloy body, stainless steel connectors; gold plated beryllium copper contacts.

WEIGHT: 150 g (5.2 oz.) maximum

PHYSICAL DIMENSIONS:

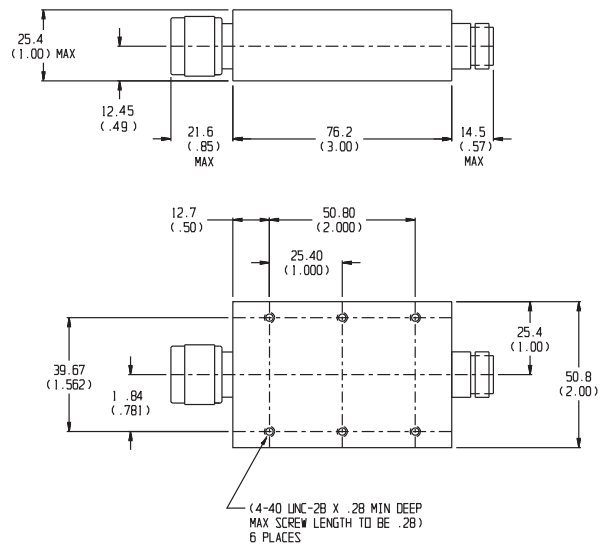

NOTE:

1. All dimensions are given in mm (inches) and tolerances are .X±0.5 (0.02) & .XX+0.25 (0.01), unless otherwise specified.
2. Unit available with RoHS compliant materials, specify when ordering

MODEL NUMBER DESCRIPTION:

Example:

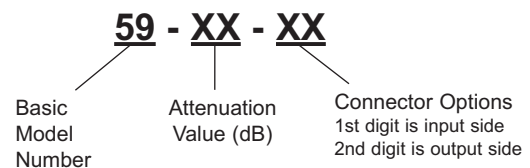

Model 68 High Power Fixed Coaxial Attenuator

dc to 4.0 GHz
100 Watts

Convection Cooled

RoHS

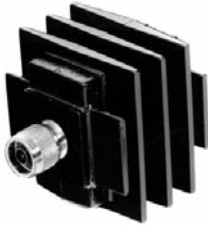

Features

- /// Precision Connectors with high temperature support beads.
- /// Designed to meet environmental requirements of MIL-DTL-3933.
- /// 10 Kilowatts peak, Convection Cooled
- /// Wireless Applications - Optimized for use in the communications bands.

Specifications

NOMINAL IMPEDANCE: 50 Ω

FREQUENCY RANGE: dc to 4.0 GHz

MAXIMUM DEVIATION OVER FREQUENCY:

Nominal ATTN (dB)	Deviation (dB)
1, 2	± 1.20
3, 6, 10, 20, 30	± 1.25
40	± 2.00

MAXIMUM SWR:

Frequency (GHz)	SWR
dc - 4	1.20

PHYSICAL DIMENSIONS:

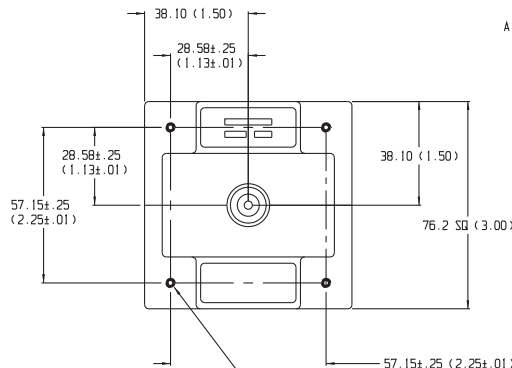

Connector	DIM A
N Male	22.9 (0.90)
N Female	15.0 (0.59)

(#6-32 UNC-2B) THRU 1ST FIN
4 HOLES BOTH ENDS

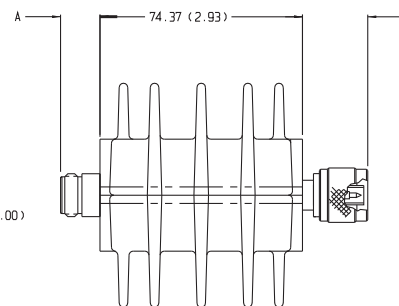

NOTE:

1. All dimensions are given in mm (inches) and are maximum, unless otherwise specified.
2. Unit available with RoHS compliant materials, specify when ordering.

POWER RATING (mounted horizontally): 100 watts average (unidirectional) to 25°C ambient temperature, derated linearly to 10 watts @ 125°C. Note: 3 dB model can handle 200 Watts average (unidirectional). 10 kilowatts peak (5 μsec pulse width; 0.5% duty cycle). Maximum power rating into output port is 10% of the average power rating.

POWER COEFFICIENT: <0.00025 dB/dB/watt

TEMPERATURE COEFFICIENT: <0.0004 dB/dB/°C

TEMPERATURE RANGE: -55°C to 100°C

TEST DATA: Insertion Loss and SWR Testing performed across frequency range. Test data available at additional cost.

CONNECTORS: Type N connectors per MIL-STD-348 interface dimensions - mate nondestructively with MIL-C-39012 connectors.

Connector Options

Type/Description

3	Type N, Female
4	Type N, Male

CONSTRUCTION: Aluminum alloy body, stainless steel connectors; gold plated beryllium copper contacts.

WEIGHT: 500 g (18 oz.) maximum

MODEL NUMBER DESCRIPTION:

Example:

68 - XX - XX

Basic Model Number

Attenuation Value (dB)

Connector Options
1st digit is input side
2nd digit is output side

Fixed Coaxial Attenuators



Model 48 High Power Fixed Coaxial Attenuator

dc to 18.0 GHz
100 Watts

Type N or 3.5mm Connectors



TEMPERATURE COEFFICIENT: <0.0004 dB/dB/°C

TEMPERATURE RANGE: -55°C to 125°C

TEST DATA: Insertion loss test data supplied at 0.05, 4.0, 8.0, 12.4, and 18.0 GHz. Other test data can be provided at additional cost.

CONNECTORS: Type N connectors per MIL-STD-348 interface dimensions - mate nondestructively with MIL-C-39012 connectors.

3.5mm (Male/Female) connectors - mate nondestructively with SMA per MIL-C-39012, 2.92mm and other 3.5mm connectors.

Features

- Designed to meet environmental requirements of MIL-DTL-3933.
- Low Intermodulation option available.
- Rugged injection molded connectors.

Specifications

NOMINAL IMPEDANCE: 50 Ω

FREQUENCY RANGE: dc to 18.0 GHz

MAXIMUM DEVIATION OVER FREQUENCY (dB):			
Nominal ATTN (dB)	48	48 LIM	
		dc-8 GHz	8-18 GHz
6	± 2.00	---	---
10	± 1.25	± 1.00	+3.0/-0.0
20	± 0.75	± 1.00	+3.0/-0.0
30, 40	± 1.00	± 1.00	+3.0/-0.0

MAXIMUM SWR:				
Frequency (GHz)	48			48 LIM
	6 dB	10 dB	20, 30, 40 dB	
dc - 8	1.30	1.40	1.25	1.40
8 - 12.4	1.45	1.40	1.35	1.45
12.4 - 18	1.60	1.55	1.45	1.45

POWER RATING (mounted horizontally): 100 watts average (unidirectional) to 25°C ambient temperature, derated linearly to 10 watts @ 125°C. 1 kilowatt peak (5 μsec pulse width; 5% duty cycle). Maximum power rating into output port is 10 Watts average.

3rd ORDER INTERMODULATION (48-XX-XX-LIM only): Reflected Levels (IM3), -90 dBc & Through Levels (IM3), -100 dBc with two input signals @ 869 MHz and 891 MHz with average carrier power levels of +43 dBm each.

POWER COEFFICIENT: <0.00015 dB/dB/watt

Connector Options	Type/Description
1	3.5mm, Female
2	3.5mm, Male
3	Type N, Female
4	Type N, Male

CONSTRUCTION: Black, finned aluminum body, stainless steel connectors, gold plated beryllium copper contacts.

WEIGHT: 320 g (11 oz.) maximum

PHYSICAL DIMENSIONS:

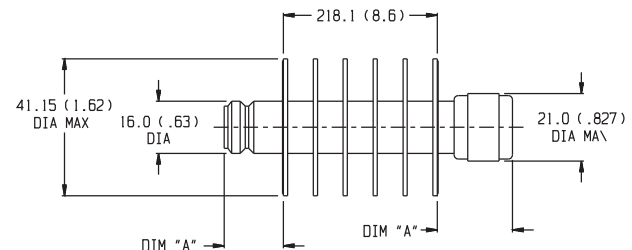

Connector	DIM A
3.5mm Female	13.2 (0.52)
3.5mm Male	14.0 (0.55)
N Male	24.1 (0.95)
N Female	19.0 (0.75)

NOTE:

- All dimensions are given in mm (inches) and are maximum, unless otherwise specified.
- Unit available with RoHS compliant materials, specify when ordering.

MODEL NUMBER DESCRIPTION:

Example:

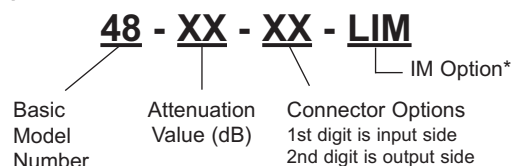

* Add -LIM to entire model number for Low Intermodulation option. Option is not available through Express.

Model 73 High Power Fixed Coaxial Attenuator

dc to 8.5 GHz
100 Watts



Type N Connectors



Features

- /// Compact Construction - Lowest size/power ratio.
- /// Quality connectors with special high temperature support beads.
- /// Designed to meet environmental requirements of MIL-DTL-3933.

Specifications

NOMINAL IMPEDANCE: 50 Ω

FREQUENCY RANGE: dc to 8.5 GHz

Nominal ATTN (dB)	Deviation (dB)	
	dc-4 GHz	4 - 8.5 GHz
3, 6, 10, 20, 30	± 0.75	± 0.75
40	± 0.50	± 1.00

Frequency (GHz)	SWR
dc - 4	1.25
4 - 8.5	1.35

PHYSICAL DIMENSIONS:

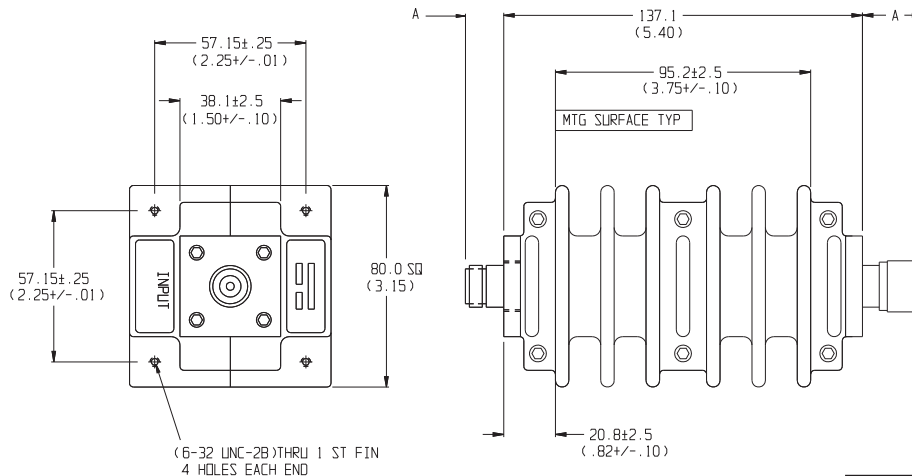

NOTE:

- All dimensions are given in mm (inches) and are maximum, unless otherwise specified.
- Unit available with RoHS compliant materials, specify when ordering.

Connector	DIM A
N Male	22.9 (0.90)
N Female	15.0 (0.59)

POWER RATING (mounted horizontally with fins vertical): 100 watts average (unidirectional) to 35°C ambient temperature, derated linearly to 10 watts @ 125°C. Note: 3 dB model can handle 200 Watts average (unidirectional). 5 kilowatt peak (5 μsec pulse width; 1.0% duty cycle). Maximum power rating into output port is 20 watts average.

POWER COEFFICIENT: <0.0003 dB/dB/watt

TEMPERATURE COEFFICIENT: <0.0004 dB/dB/°C

TEMPERATURE RANGE: -55°C to 125°C

TEST DATA: Insertion loss test data supplied at 0.05, 4.0, and 8.5 GHz. Other test data can be provided at additional cost.

CONNECTORS: Type N connectors per MIL-STD-348 interface dimensions - mate nondestructively with MIL-C-39012 connectors.

Connector Options	Type/Description
3	Type N, Female
4	Type N, Male

CONSTRUCTION: Aluminum alloy body, stainless steel connectors; gold plated beryllium copper contacts.

WEIGHT: 1130 g (2 lbs, 8 oz.) maximum

MODEL NUMBER DESCRIPTION:

Example:

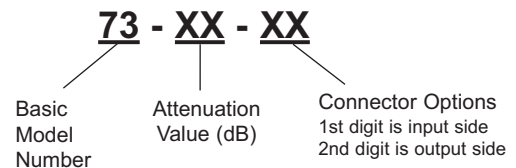

Fixed Coaxial Attenuators



Model 40

Model 57

High Power Fixed Coaxial Attenuator

Type N Connectors

dc to 1.5 GHz

dc to 5.0 GHz

150 Watts

RoHS



Features

- Quality connectors with special high temperature support beads.
- Designed to meet environmental requirements of MIL-DTL-3933.

Specifications

NOMINAL IMPEDANCE: 50 Ω

FREQUENCY RANGE: Model 40: dc to 1.5 GHz
Model 57: dc to 5.0 GHz

MAXIMUM DEVIATION OVER FREQUENCY:			
Nominal ATTN (dB)	Deviation (dB)		
	40	57	57-LIM
3*	± 0.50	± 1.25	---
6, 10	± 0.50	± 1.25	± 1.75
20, 30	± 0.50	± 1.50	± 2.00
40	± 0.50	± 2.00	± 2.00

MAXIMUM SWR:		
Frequency (GHz)	Input	Output
dc - 2 (1.5*)	1.10	1.20 (1.10*)
2 - 5	1.15	1.20

* Model 40 only!

3rd ORDER INTERMODULATION (57-XX-XX-LIM ONLY): Reflected Levels (IM3), -100 & Through Levels (IM3), -110 dBc with two input signals @ 869 MHz and 891 MHz with average carrier power levels of +43 dBm each. Option only available 6, 10, 20, 30, 40 dB.

PHYSICAL DIMENSIONS:

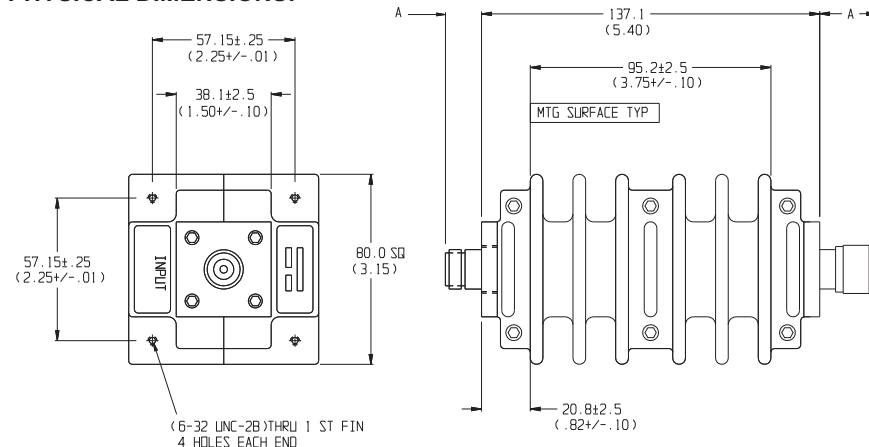

Connector	DIM A
N Male	22.9 (0.90)
N Female	15.0 (0.59)

NOTE:

- All dimensions are given in mm (inches) and are maximum, unless otherwise specified.
- Unit available with RoHS compliant materials, specify when ordering.

POWER RATING (mounted horizontally with fins vertical): 150 watts **average (unidirectional)** to 55°C ambient temperature, derated linearly to 10% @ 125°C. Note: 3 dB model can handle 300 Watts **average (unidirectional)**. 10 kilowatt **peak** (5 μsec pulse width; 0.75% duty cycle). Maximum power rating into output port is 20 watts average.

POWER COEFFICIENT: <0.0001 dB/dB/watt

TEMPERATURE COEFFICIENT: <0.0004 dB/dB/°C

TEMPERATURE RANGE: -55°C to 125°C

TEST DATA: Insertion loss test data supplied at 0.05, 1, 2, 3, 4, and 5 GHz (Model 40 at 0.05 and 1.5 GHz). Other test data can be provided at additional cost.

CONNECTORS: Type N connectors per MIL-STD-348 interface dimensions - mate nondestructively with MIL-C-39012 connectors.

Connector Options	Type/Description
3	Type N, Female
4	Type N, Male

CONSTRUCTION: Aluminum alloy body, stainless steel connectors; gold plated beryllium female copper contacts and stainless steel male contacts.

WEIGHT: 1,130 g (2 lbs, 8 oz.) maximum

MODEL NUMBER DESCRIPTION:

Example:

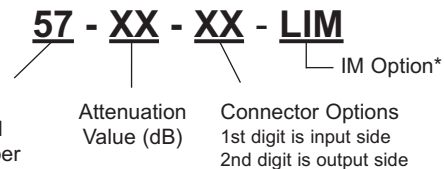

* Add -LIM for Low Intermodulation option. Option only available with Model 57 in 6, 10, 20, 30, 40 dB and is not available through Express.

Model 65 High Power Fixed Coaxial Attenuator

dc to 2.5 GHz
150 Watts

Conduction/Convection Cooled



Features

- /// **Compact Construction** - Lowest size/power ratio.
- /// **Flexible Mounting Position** - The units may be mounted in horizontal (fins up) or vertical position.
- /// **Rugged Construction** - Quality connectors with special high temperature support beads.

Specifications

NOMINAL IMPEDANCE: 50 Ω

FREQUENCY RANGE: dc to 2.5 GHz

MAXIMUM DEVIATION OVER FREQUENCY:

Nominal ATTN (dB)	Deviation (dB)
3, 6, 10, 20, 30	± 1.00

MAXIMUM SWR:

Frequency (GHz)	SWR
dc - 2.5	1.20

PHYSICAL DIMENSIONS:

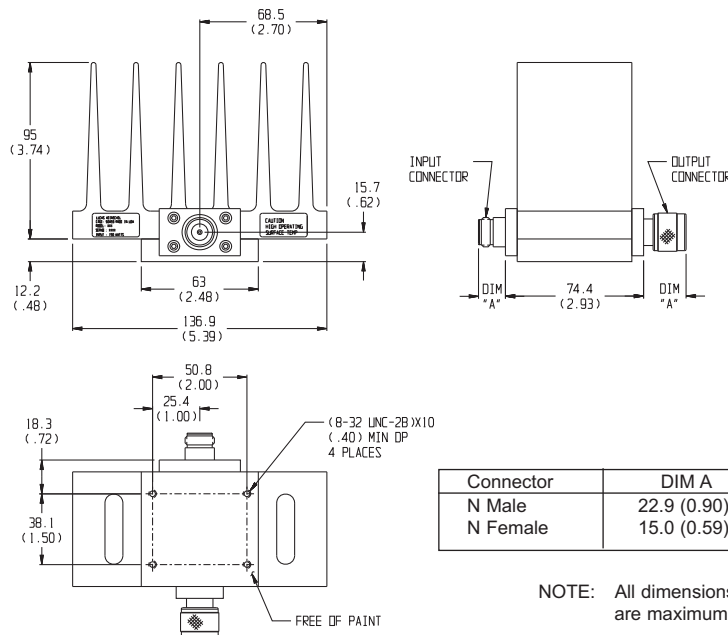

POWER RATING 150 watts **average (unidirectional)**, 10 kilowatts **peak** (5 μsec pulse width; 0.5 % duty cycle) with case temperature held within **100 °C maximum** with appropriate convection cooling and/or conductive heat sink. Maximum power rating into output port is 20 watts average.

POWER COEFFICIENT: <0.0003 dB/dB/watt

TEMPERATURE COEFFICIENT: <0.0004 dB/dB/°C

TEMPERATURE RANGE: -55°C to 100°C (case temp.)

TEST DATA: Insertion loss test data supplied at 0.05, 0.5, 1.0, 1.5, 2.0 and 2.5 GHz.

CONNECTORS: Type N connectors per MIL-STD-348 interface dimensions - mate nondestructively with MIL-C-39012 connectors.

Connector Options	Type/Description
3	Type N, Female
4	Type N, Male

CONSTRUCTION: Aluminum alloy body, stainless steel connectors; gold plated beryllium copper contacts.

WEIGHT: 850 g (1 lbs., 14 oz.) maximum

MODEL NUMBER DESCRIPTION:

Example:

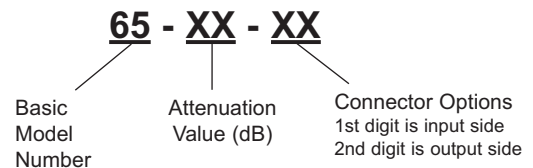

Connector	DIM A
N Male	22.9 (0.90)
N Female	15.0 (0.59)

NOTE: All dimensions are given in mm (inches) and are maximum, unless otherwise specified.

Fixed Coaxial Attenuators



Model 49 High Power Fixed Coaxial Attenuator

dc to 8.5 GHz
150 Watts



Conduction/Convection Cooled

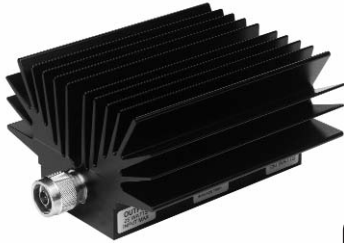

Features

- Quality connectors with special high temperature support beads.
- Designed to meet environmental requirements of MIL-DTL-3933.
- Flexible Mounting Position - The units may be mounted in horizontal (fins up) or vertical position.

Specifications

NOMINAL IMPEDANCE: 50 Ω

FREQUENCY RANGE: dc to 8.5 GHz

MAXIMUM DEVIATION OVER FREQUENCY (dB):				
Nominal ATTN (dB)	dc-4 GHz		4 - 8.5 GHz	
	49	49-LIM	49	49-LIM
3, 6	± 0.40	---	± 0.75	---
10, 20	± 0.40	± 0.70	± 0.75	± 1.25
30	± 0.40	± 0.70	± 0.75	± 1.75
40	± 0.50	± 0.70	± 1.00	± 1.75

MAXIMUM SWR:	
Frequency (GHz)	SWR
dc - 4	1.25
4 - 8.5	1.35

3rd ORDER INTERMODULATION (49-XX-XX-LIM ONLY): Reflected Levels (IM3), -95 & Through Levels (IM3), -110 dBc with two input signals @ 869 MHz and 891 MHz with average carrier power levels of +43 dBm each.

POWER RATING (mounted horizontally or vertically): 150 watts average (unidirectional) to 35°C ambient temperature, derated linearly to 15 watts @ 125°C. 5 kilowatt peak (5 μsec pulse width; 1.5% duty cycle). Maximum power rating into output port is 25 watts average.

POWER COEFFICIENT: <0.0001 dB/dB/watt

TEMPERATURE COEFFICIENT: <0.0004 dB/dB/°C

TEMPERATURE RANGE: -55°C to 125°C

TEST DATA: Insertion loss test data supplied at 0.05, 4.0, and 8.5 GHz. Other test data can be provided at additional cost.

CONNECTORS: Type N connectors per MIL-STD-348 interface dimensions - mate nondestructively with MIL-C-39012 connectors.

Connector Options	Type/Description
3	Type N, Female
4	Type N, Male

CONSTRUCTION: Aluminum alloy body, stainless steel connectors; gold plated beryllium copper female contacts or stainless steel male contacts. (-LIM option uses different connector and contact materials)

WEIGHT: 1,450 g (3 lbs, 3 oz.) maximum

PHYSICAL DIMENSIONS:

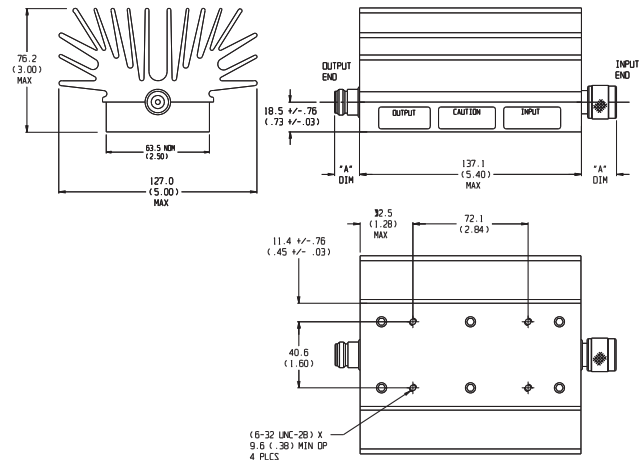

Connector	DIM A
N Male	22.9 (0.90)
N Female	15.0 (0.59)

NOTE:

- All dimensions are given in mm (inches) and are maximum, unless otherwise specified.
- Unit available with RoHS compliant materials, specify when ordering.

MODEL NUMBER DESCRIPTION:

Example:

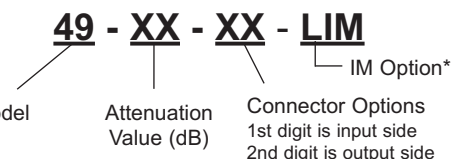

*Add -LIM for Low Intermodulation option. Option only available in 10, 20, 30, and 40 dB and is not available through Express.

Model 66 High Power Fixed Coaxial Attenuator

dc to 18.0 GHz
150 Watts

Convection Cooled

RoHS



Features

- /// Quality injection molded connectors.
- /// Designed to meet environmental requirements of MIL-DTL-3933.
- /// Broadband performance, ideal for test applications.

Specifications

NOMINAL IMPEDANCE: 50 Ω

FREQUENCY RANGE: dc to 18.0 GHz

MAXIMUM DEVIATION OVER FREQUENCY:	
Nominal ATTN (dB)	Deviation (dB)
10	± 2.00
20, 30, 40	± 1.50

MAXIMUM SWR:		
Frequency (GHz)	10	20, 30, 40 dB
dc - 18	1.90	1.60

POWER RATING (mounted horizontally): 150 watts average (unidirectional) @ case temperature of -55°C to +100 °C maximum. 1 kilowatt peak (5 μsec pulse width; 7.5% duty cycle). Maximum power rating into output port is 10 watts average.

POWER COEFFICIENT: <0.0002 dB/dB/watt

TEMPERATURE COEFFICIENT: <0.0004 dB/dB/°C

TEMPERATURE RANGE: -55°C to 100°C (case temp.)

TEST DATA: Insertion loss test data supplied at 0.05, 4.0, 8.0, 12.4 and 18.0 GHz.

CONNECTORS: Type N connectors per MIL-STD-348 interface dimensions - mate nondestructively with MIL-C-39012 connectors.

Connector Options	Type/Description
3	Type N, Female
4	Type N, Male

CONSTRUCTION: Aluminum alloy body, stainless steel connectors; gold plated beryllium copper contacts.

WEIGHT: 480 g (17 oz.) maximum

MODEL NUMBER DESCRIPTION:

Example:

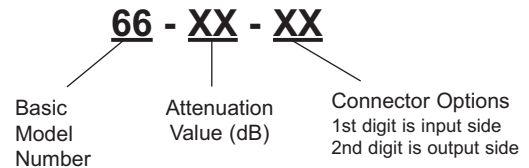

PHYSICAL DIMENSIONS:

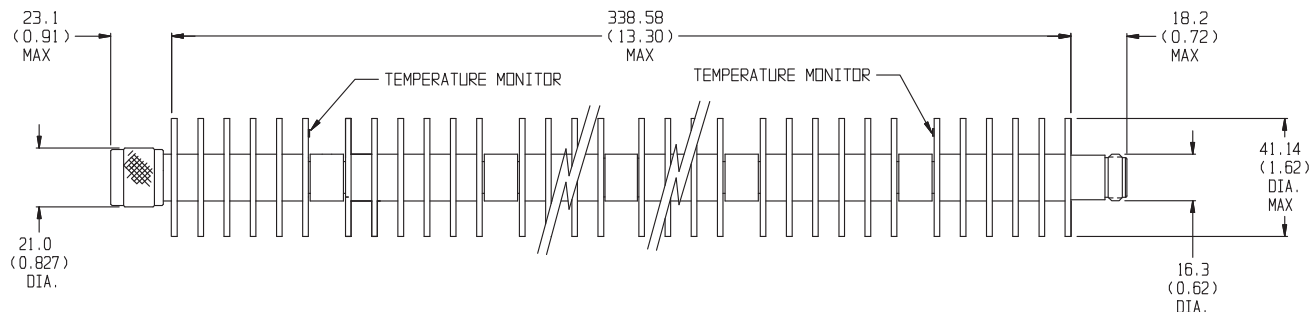

NOTE:

1. All dimensions are given in mm (inches) and are maximum, unless otherwise specified.
2. Unit available with RoHS compliant materials, specify when ordering.

Fixed Coaxial Attenuators



Model 45

Model 58

High Power Fixed Coaxial Attenuator

Convection Cooled

dc to 1.5 GHz

dc to 5.0 GHz

250 Watts

RoHS



Features

- Quality connectors with special high temperature support beads.
- Designed to meet environmental requirements of MIL-DTL-3933.

Specifications

NOMINAL IMPEDANCE: 50 Ω

FREQUENCY RANGE: Model 45: dc to 1.5 GHz
Model 58: dc to 5.0 GHz

Nominal ATTN (dB)	MAXIMUM DEVIATION OVER FREQUENCY:		
	45	58	58 LIM
3*, 6	± 0.50	± 1.50	---
10, 20	± 0.50	± 1.50	± 2.00
30, 40	± 0.50	± 1.75	± 3.00

Frequency (GHz)	MAXIMUM SWR:			
	45/58		58 LIM	
	Input	Output	Input	Output
dc - 2 (1.5*)	1.10	1.20 (1.10*)	1.20	1.25
2 - 5	1.15	1.25	1.20	1.25

* Model 45 only!

3rd ORDER INTERMODULATION (58-XX-XX-LIM ONLY): Reflected Levels (IM3), -100 & Through Levels (IM3), -110 dBc with two input signals @ 869 MHz and 891 MHz with average carrier power levels of +43 dBm each.

PHYSICAL DIMENSIONS:

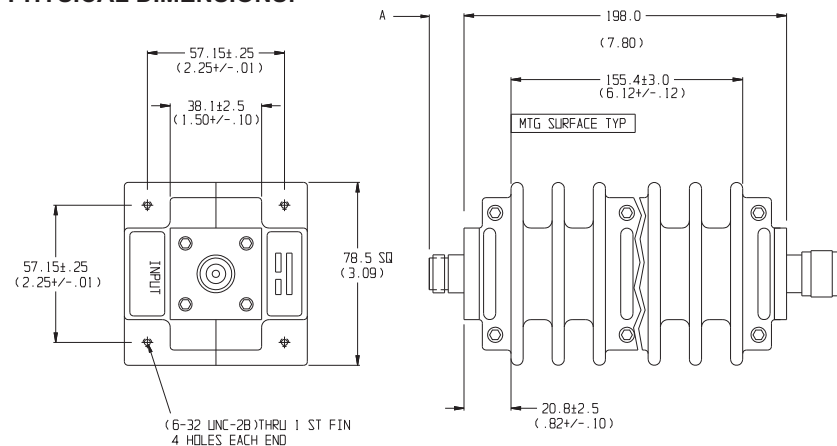

Connector	DIM A
N Male	22.9 (0.90)
N Female	15.0 (0.59)

NOTE:

- All dimensions are given in mm (inches) and are maximum, unless otherwise specified.
- Unit available with RoHS compliant materials, specify when ordering.

POWER RATING (mounted horizontally with fins vertical): 250 watts **average** (unidirectional) to 55°C ambient temperature, derated linearly to 10% @ 125°C. 10 kilowatt **peak** (5 μsec pulse width; 1.25% duty cycle). Maximum power rating into output port is 50 watts average. Note: Model 45-3-XX is rated for 500 Watts **average** (unidirectional) into the input and 250 Watts average (maximum) into the output port.

POWER COEFFICIENT: <0.0001 dB/dB/watt

TEMPERATURE COEFFICIENT: <0.0004 dB/dB/°C

TEMPERATURE RANGE: -55°C to 125°C

TEST DATA: Insertion loss test data supplied at 0.05, 1, 2, 3, 4 and 5 GHz (Model 45 at 0.05 and 1.5 GHz). Other test data can be provided at additional cost.

CONNECTORS: Type N connectors per MIL-STD-348 interface dimensions - mate nondestructively with MIL-C-39012 connectors.

Connector Options	Type/Description
3	Type N, Female
4	Type N, Male

CONSTRUCTION: Aluminum alloy body, stainless steel connectors; gold plated beryllium copper contacts.

WEIGHT: 1,530 g (6 lbs, 3 oz.) maximum

MODEL NUMBER DESCRIPTION:

Example:

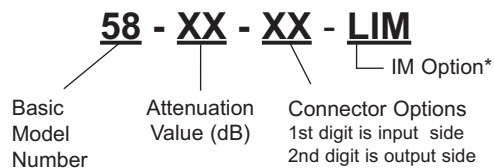

*Add -LIM for Low Intermodulation option. Option only available with Model 58 in 10, 20, 30, 40 dB and is not available through Express.

Model 67 High Power Fixed Coaxial Attenuator

dc to 12.7 GHz
350 Watts

Forced Cooled



Features

- /// Precision Injection Molded Connectors.
- /// Designed to meet environmental requirements of MIL-DTL-3933.
- /// Broadband performance, ideal for test applications.

Specifications

NOMINAL IMPEDANCE: 50 Ω

FREQUENCY RANGE: dc to 12.7 GHz

MAXIMUM DEVIATION OVER FREQUENCY:

Nominal ATTN (dB)	Deviation (dB)	
	dc-8 GHz	8 -12.7 GHz
10	± 2.00	+6.00/-0.00
20, 30	± 2.50	+6.00/-0.00

MAXIMUM SWR:

Frequency (GHz)	SWR
dc - 8	1.30
8 - 12.7	1.60

POWER RATING (mounted horizontally): 350 watts average (unidirectional) @ 25°C ambient temperature. Case temperature must be held to **100°C maximum**. 5 kilowatt **peak** (5 μsec pulse width; 3.5% duty cycle). Maximum power rating into output port is 10 watts average.

POWER COEFFICIENT: <0.0001 dB/dB/watt

TEMPERATURE COEFFICIENT: <0.0004 dB/dB/°C

TEMPERATURE RANGE: -55°C to 100°C (case temp.)

TEST DATA: Insertion loss test data supplied at 0.05, 0.5, 4.0, 8.0 & 12.0 GHz.

CONNECTORS: Type N connectors per MIL-STD-348 interface dimensions - mate nondestructively with MIL-C-39012 connectors.

Connector Options	Type/Description
3	Type N, Female
4	Type N, Male

CONSTRUCTION: Aluminum alloy body, stainless steel connectors; gold plated beryllium copper contacts.

WEIGHT: 1200 g (43 oz.) maximum

MODEL NUMBER DESCRIPTION:

Example:

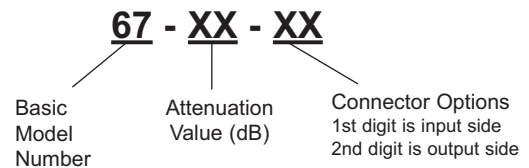

PHYSICAL DIMENSIONS:

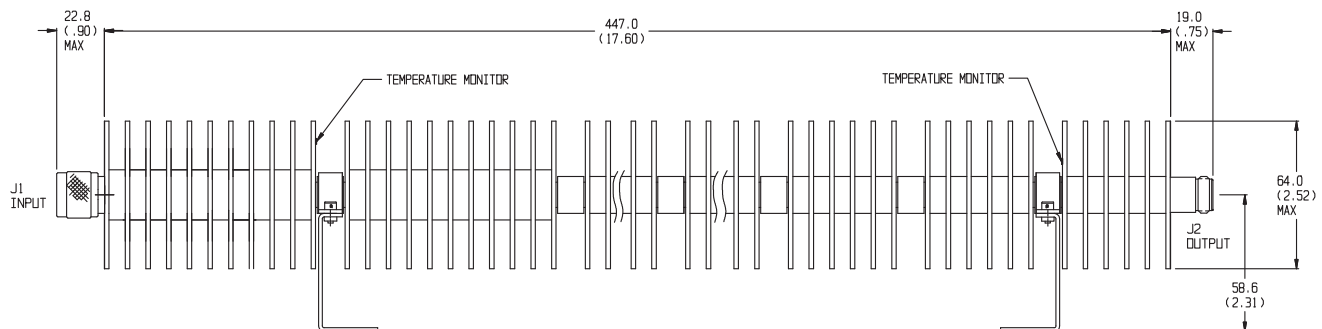

NOTE:

1. All dimensions are given in mm (inches) and are maximum, unless otherwise specified.
2. Unit available with RoHS compliant materials, specify when ordering.

Fixed Coaxial Attenuators



Model 53 High Power Fixed Coaxial Attenuator

dc to 2.5 GHz
500 Watts

Conduction/Convection Cooled



Features

- /// Quality connectors with special high temperature support beads.
- /// Designed to meet environmental requirements of MIL-DTL-3933.
- /// Flexible Mounting Position - The units may be mounted in horizontal (fins up) or vertical position.
- /// Low Intermodulation Distortion Option.

Specifications

NOMINAL IMPEDANCE: 50 Ω

FREQUENCY RANGE: dc to 2.5 GHz

MAXIMUM DEVIATION OVER FREQUENCY:		
Nominal ATTN (dB)	Deviation (dB)	
	53	53 LIM
3, 6	± 1.00	---
10, 20, 30, 40	± 1.00	± 1.20

MAXIMUM SWR:		
Frequency (GHz)	53	53 LIM
dc - 2.5	1.10	1.15

3rd ORDER INTERMODULATION (53-XX-XX-LIM ONLY): Reflected Levels (IM3), -100 & Through Levels (IM3), -110 dBc with two input signals @ 869 MHz and 891 MHz with average carrier power levels of +43 dBm each.

POWER RATING (mounted horizontally with fins vertical): 500 watts **average (unidirectional)** to 35°C ambient temperature, derated linearly to 50 watts @ 125°C. 10 kilowatt **peak** (5 μsec pulse width; 2.5% duty cycle). Maximum power rating into output port is 45 watts average. Note: 3 dB units are rated for 750 Watts **average (unidirectional)** into the input and 250 Watts **average (maximum)** into the output port.

POWER COEFFICIENT: <0.0001 dB/dB/watt

TEMPERATURE COEFFICIENT: <0.0004 dB/dB/°C

TEMPERATURE RANGE: -55°C to 125°C

TEST DATA: Insertion loss test data supplied at 0.05, 2.5 GHz. Other test data can be provided at additional cost.

CONNECTORS: Type N connectors per MIL-STD-348 interface dimensions - mate nondestructively with MIL-C-39012 connectors.

Connector Options	Type/Description
3	Type N, Female
4	Type N, Male

CONSTRUCTION: Aluminum alloy body, gold plated beryllium copper contacts.

WEIGHT: 3,640 g (8 lbs.) maximum

PHYSICAL DIMENSIONS:

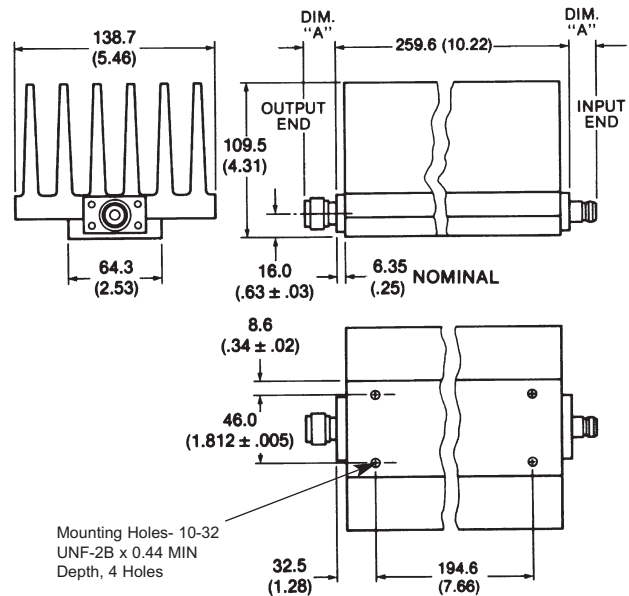

Mounting Holes- 10-32 UNF-2B x 0.44 MIN Depth, 4 Holes

Connector	DIM A
N Male	22.9 (0.90)
N Female	15.0 (0.59)

NOTE: All dimensions are given in mm (inches) and are maximum, unless otherwise specified.

MODEL NUMBER DESCRIPTION:

Example:

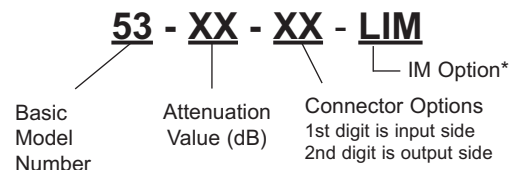

*Add -LIM for Low Intermodulation option. Option only available in 10, 20, 30 and 40 dB and is not available through Express.

Model 81 High Power Fixed Coaxial Attenuator

dc to 10.0 GHz
500 Watts



Conduction/Convection Cooled



Features

- Quality connectors with special high temperature support beads.
- Designed to meet environmental requirements of MIL-DTL-3933.

Specifications

NOMINAL IMPEDANCE: 50 Ω
FREQUENCY RANGE: dc to 10.0 GHz

MAXIMUM DEVIATION OVER FREQUENCY (dB):		
NOM ATTN (dB)	Deviation	
	dc - 7.0 GHz	7.0 - 10.0 GHz
10, 20, 30, 40	±3.0	+5 / -0 dB

MAXIMUM SWR:	
Frequency (GHz)	SWR
dc - 8.0	1.65
8.0 - 10.0	1.95

PHYSICAL DIMENSIONS:

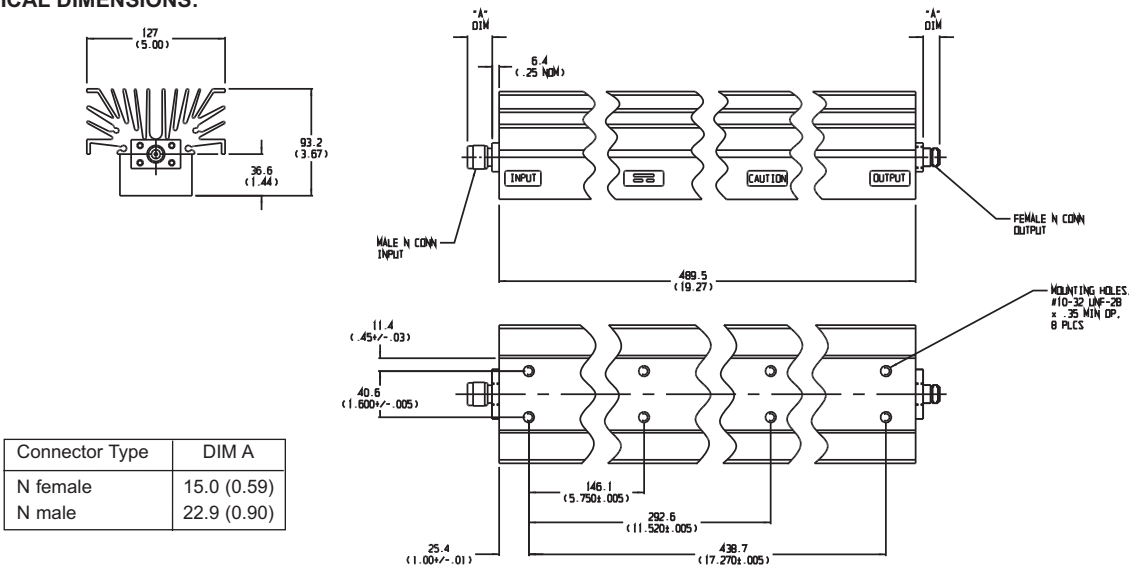

NOTE: All dimensions are given in mm (inches) and are maximum, unless otherwise specified.

POWER RATING (assuming unobstructed air flow and natural convection around unit): 500 watts **average** (unidirectional) to 35°C ambient temperature, derated linearly to 50 watts @ 125°C. 5 kilowatt **peak** (5 μsec pulse width; 1.5% duty cycle). Maximum power into output is 20 Watts **average**.

POWER COEFFICIENT: <0.0001 dB/dB/Watt

TEMPERATURE COEFFICIENT: <0.0004 dB/dB/°C

TEMPERATURE RANGE: -55°C to +125°C

TEST DATA: Insertion Loss and SWR Test data supplied at 0.05, 2.0, 4.0, 6.0, 8.0 and 10 GHz. Other test data can be provided at additional cost.

CONNECTOR: Type N connectors - mate nondestructively with MIL-C-39012 connectors .

Options	Type/Description
3	Type N, Female
4	Type N, Male

CONSTRUCTION: Black, finned aluminum body, stainless steel or silver plated brass connectors with gold plated beryllium copper or stainless steel N male contacts.

WEIGHT: Net 1.45 kg (3 lbs, 4 oz) maximum

MODEL NUMBER DESCRIPTION:

81 - XX - XX

Basic Model Number

Attenuation Value

Connector Options
- 1st Digit is input side
- 2nd digit is output side.

Model 82 High Power Coaxial Attenuator

dc to 3.0 GHz
1,000 Watts

Type N Connectors



Features

- Quality connectors with special high temperature support beads.
- Designed to meet environmental requirements of MIL-DTL-3933.

Specifications

NOMINAL IMPEDANCE: 50 Ω

FREQUENCY RANGE: dc to 3.0 GHz

MAXIMUM DEVIATION OVER FREQUENCY (dB):		
NOM ATTN (dB)	Deviation	
	dc - 1.5 GHz	1.5 - 3.0 GHz
10, 20, 30, 40	±0.75	+1.5, -0.5 dB

MAXIMUM SWR:	
Frequency (GHz)	SWR
dc - 1.5	1.15
1.5 - 3.0	1.25

PHYSICAL DIMENSIONS:

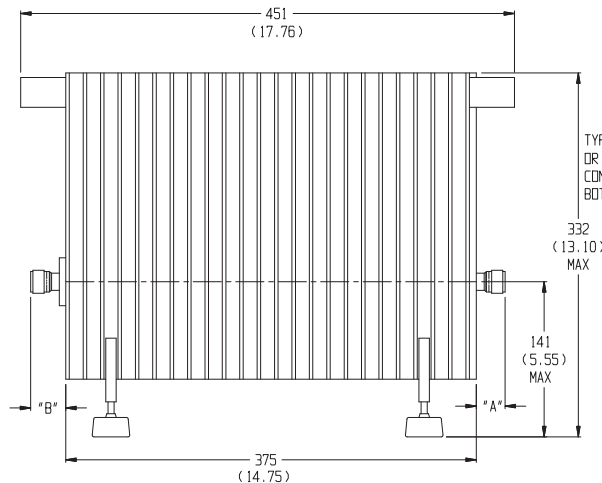

POWER RATING (assuming unobstructed air flow and natural convection around unit): 1,000 watts **average** (unidirectional) to 25°C ambient temperature, derated linearly to 100 watts @ 125°C. 10 kilowatt **peak** (5 μsec pulse width; 5% duty cycle). Maximum power into output is 75 Watts **average**.

POWER COEFFICIENT: <0.0001 dB/dB/Watt

TEMPERATURE COEFFICIENT: <0.0004 dB/dB/°C

TEMPERATURE RANGE: -55°C to +125°C with power derating applied.

TEST DATA: Insertion Loss and SWR measurements performed across frequency range. Test data supplied at additional cost.

CONNECTOR: Type N connectors - mate nondestructively with MIL-C-39012 connectors .

Options	Type/Description
3	Type N, Female
4	Type N, Male

CONSTRUCTION: Black, finned aluminum body, stainless steel or silver plated brass connectors with gold plated beryllium copper or stainless steel N male contacts.

WEIGHT: Net 13 kg (28.7 lbs) maximum

MODEL NUMBER DESCRIPTION:

82 - XX - XX

Basic Model Number

Attenuation Value

Connector Options

- 1st Digit is input side
- 2nd digit is output side.

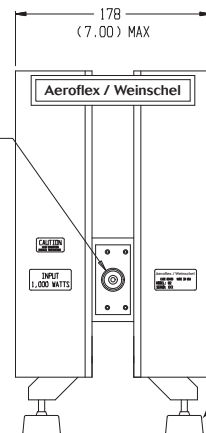

FEET ARE SPRING LOADED FOR SELF LEVELING AND ARE SHOWN FULLY EXTENDED AND CAN BE COMPRESSED UP TO 0.16 INCHES (4 PLCS)

NOTE:

- All dimensions are given in mm (inches) and are maximum, unless otherwise specified.
- Unit available with RoHS compliant materials, specify when ordering.

Connector Type	DIM A	DIM B
N female	15.0 (0.59)	21.4 (0.84)
N male	22.9 (0.90)	29.3 (1.15)

Attenuator Sets

dc to 18.0/28.0 GHz



Model AS-6
(Type N)



Model AS-18
(Precision Type N)



Model AS-20
(3.5mm)

Features

- /// **Test Data:** Test Data for each attenuator is provided.
- /// **Data furnished:** AS-6 and AS-18, Insertion loss & SWR ports 1 and 2 test data supplied at 0.05, 4.0, 8.0, 12.4 and 18.0 GHz and AS-20, Insertion loss & SWR ports 1 and 2 test data supplied at 0.05, 4.0, 8.0, 12.4, 18.0 and 26.5 GHz.
- /// **Wide Temperature Range:** -55 °C to 125 °C. Full rated power to 25 °C. Derated Linearity to 0.5 watts @ 125 °C.
- /// **Uniform Phase Characteristics:** Excellent unit-to-unit tracking and phase linearly with frequency.
- /// **Rugged Construction:** Designed to meet all environmental requirements of MIL-DTL-3933.
- /// **High Repeatability Connectors:**
 - AS-6: Type N per MIL-STD-348
 - AS-18: Precision N per MIL-STD-348
 - AS-20: Precision 3.5mm
- /// **Durable Storage Case.**

Specifications

Set Model Number	Standard Model Number	Nominal Values (dB)	Frequency Range (GHz)	Average Power (W)	Connector Type	Maximum* SWR	Page No.**
AS-6	2	3, 6, 10, 20	dc-18 GHz	5	N	1.15 - 1.35	32
AS-18	44	1, 3, 6, 10, 20, 30	dc-18 GHz	5	N	1.15 - 1.25	33
AS-20	56	3, 6, 10, 20, 30	dc-28 GHz	2	3.5mm	1.10 - 1.25	27

*Varies with frequency.

**Refer to indicated page for more detailed attenuator specifications.

STORAGE CASE DIMENSIONS:

- Model AS-6: 136.5mm (5-3/8 in) long x 125.4mm (4-15/16 in) wide x 35.6mm (2-3/16 in) high
- Model AS-18: 215.9mm (8.5 in) long x 273mm (10-3/4 in) wide x 63.5mm (2-1/2 in) high
- Model AS-20: 139.7mm (5-1/2 in) long x 123.8mm (4-7/8 in) wide x 60.3mm (2-3/8 in) high