

M8190A Arbitrary Waveform Generator

12 GSa/s Arbitrary Waveform Generator



Table of Contents

High Resolution + Wide Bandwidth in an AWG.....	03
M8190A Arbitrary Waveform Generator (AWG)	04
Enhance Your Reality	05
Versatile	06
Memory	07
Configure	08
Multi-Level Signals	09
Scenarios	10
Infinite Playtime	11
Headroom	13
Product Structure.....	14
Accessories	14
The Instrument.....	15
AXle.....	16
Performance Specification	17
Sequencer	36
Digital Up-Conversion	37
Definitions	39
Software	39

High Resolution + Wide Bandwidth in An AWG

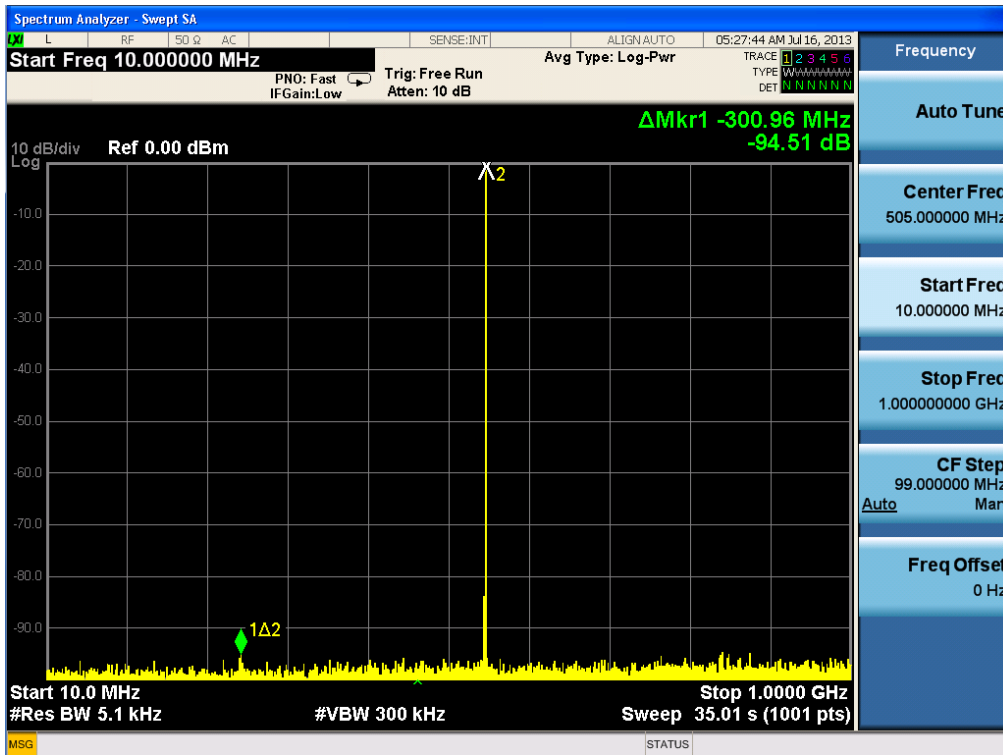

M8190A Arbitrary Waveform Generator (AWG)

M8190A at a glance

- Precision AWG with two DAC settings
 - 14-bit resolution up to 8 GSa/s
 - 12-bit resolution up to 12 GSa/s
- Variable sample rate from 125 MSa/s to 8/12 GSa/s
- Spurious-free-dynamic range (SFDR) up to 90 dBc typical
- Harmonic distortion (HD) up to -72 dBc typical
- Up to 12.25 effective number of bits (ENOB)
- Up to 2 GSa arbitrary waveform memory per channel with advanced sequencing
- Analog bandwidth 5 GHz
- Optional real-time digital signal processing in Keysight Technologies, Inc. proprietary ASIC for:
 - Digital up-conversion to IF
 - Changing waveform parameters on the fly
- Form-factor: 2 U AXIe module, controlled via external PC or AXIe system controller
- Supported software: Keysight Benchlink Waveform Editor, MATLAB, LABVIEW, Keysight Signal Studio Pulsebuilder, Signal Studio WLAN, Test automation software support for MHL and HDMI; planned support for Signal Studio Multitone

Waveform file import capability

- Import waveform format by series:
 - TXT file format (Compatibility: Keysight M8190A)
 - TXT14 file format (Compatibility: Keysight M8190A)
 - BIN file format (Compatibility: Keysight M8190A Recommended as standard binary file import format.)
 - IQBIN file format (Compatibility: Keysight M8190A Recommended as standard binary file import format.)
 - BIN6030 file format (Compatibility: Keysight N6030A Arbitrary Waveform Generator, 15-Bit, 1.25 GS/s)
 - BIN5110 file format (Compatibility: Keysight 5110A)
 - N5110B Baseband Studio for Waveform Capture - Keysight
 - N5110A Baseband Studio for Waveform Streaming
 - LiCensed (SigStudioEncrypted in the SFP) file format (Compatibility: Keysight Signal Studio generated encrypted file)
 - MAT89600 (Compatibility: 89600 VSA)
 - DSA90000 (Compatibility: DSA90000 Oscilloscope)
 - CSV (Compatibility: Keysight M8190A)

Three amplifiers for different applications

- Direct DAC—optimized for best SFDR & HD
 - SFDR up to -90 dBc (typ), $f_{out} = 100$ MHz, measured DC to 1 GHz
 - Amplitude ~350 mVpp ... 700 mVpp, offset -20 mV ... +20 mV
 - Differential output
- DC amplifier ¹—optimized for serial data/time domain applications
 - Amplitude 500 mVpp ... 1.0 Vpp; (overprogramming down to 150 mV possible) output voltage window: -1.0 V ... +3.3 V
 - $t_{rise/fall, 20\% - 80\%} < 60$ ps
 - Differential output
- AC amplifier ¹—optimized to generate high voltage, high bandwidth signals
 - 50 MHz to 5 GHz bandwidth
 - Single ended, AC coupled output
 - Amplitude: 200 mVpp ... 2.0 Vpp

M8192A Multi-Channel Synchronization Module

- Phase coherent synchronization of up to 6 M8190A modules (= 12 channels)
- One trigger input can trigger up to 6 M8190A modules with deterministic latency
- Skew repeatability of 2 ps between any two channels - independent of sample rate
- Skew calibration with 50 fs delay resolution between any two channels
- 1U AXIe module for high port density

1. AMP option.



Enhance Your Reality

A better name for an advanced arbitrary waveform generator is a “signal scenario generator” or SSG.

This description signifies a level of versatility that enables you to set up complex real-world signals—whether you need precise signals to characterize the performance of a design or need to stress a device to its limits. From low-observable radar to high-density communications, testing is more realistic with precision arbitrary waveform generation from an SSG.

Take reality to the extreme: A Keysight AWG is the source of greater fidelity, delivering high resolution and wide bandwidth—simultaneously. This unique combination lets you create signal scenarios that push your designs to the limit and bring new insights to your analysis. Get bits and bandwidth—and enhance your reality.

High-quality signal generation is the foundation of reliable and repeatable measurements. The Keysight M8190A ensures accuracy and repeatability with 14-bit resolution, up to 8 GSa/s sampling rate and up to 90 dBc SFDR. High dynamic range and excellent vertical resolution gives you confidence that you are testing your device, not the signal source.

As an example, a test setup that exhibits a high error vector magnitude (EVM) reading might prevent you from seeing problems within your device under test (DUT). The level of reality possible with the M8190A minimizes problems like this.

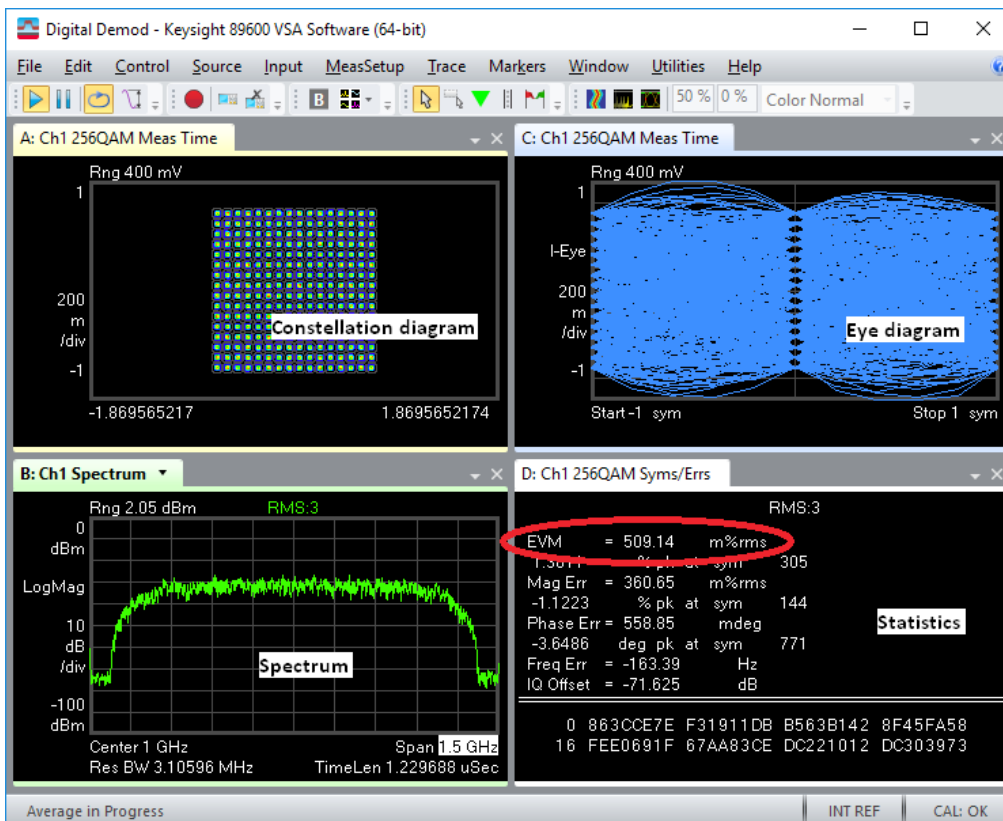

Get reliable, repeatable measurements from precise signal simulations.

Versatile

Optimize the output to match your application

An AWG is the most versatile signal scenario generator possible. Capabilities such as easy switching between 14-bit output at 8 GSa/s and 12-bit output at 12 GSa/s help you handle multiple applications and measurement requirements.

Because every application calls for different signal characteristics, the Keysight M8190A also contains three amplifiers that are optimized for I/Q signals, IF/RF output, or clean time-domain signals. You can switch between them as needed through software commands. Some applications call for Multi-channel support. The M8192 AXIe module can be plugged into the chassis ensuring alignment up to 12-channels.

Optimized for different signal characteristics

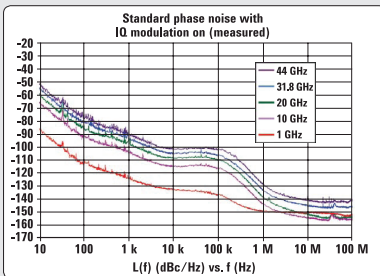

Best SFDR and HD

- Single-ended or differential output
- Amplitude 350 mV_{pp} ... 700 mV_{pp}, single-ended
- Offset -20 mV ... +20 mV
- Direct output
- Adjustable differential offset

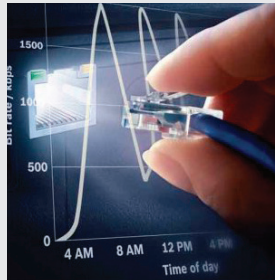

High bandwidth high voltage

- Up to 5 GHz
- Single-ended, AC coupled output
- Amplitude 200 mV_{pp} to 2.0 V_{pp}, single-ended
- AC amplifier ¹

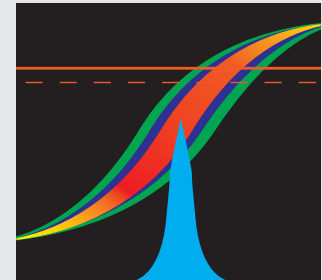

Time domain measurements low jitter

- Single-ended or differential, DC-coupled output
- Amplitude 500 mV_{pp} ... 1.0 V_{pp} single-ended
- Output voltage window -1.0 V to +3.3 V
- Transition times (20/80) < 60 ps
- DC amplifier ¹

1. AMP option.

Create Complex Signal Scenarios—Efficiently

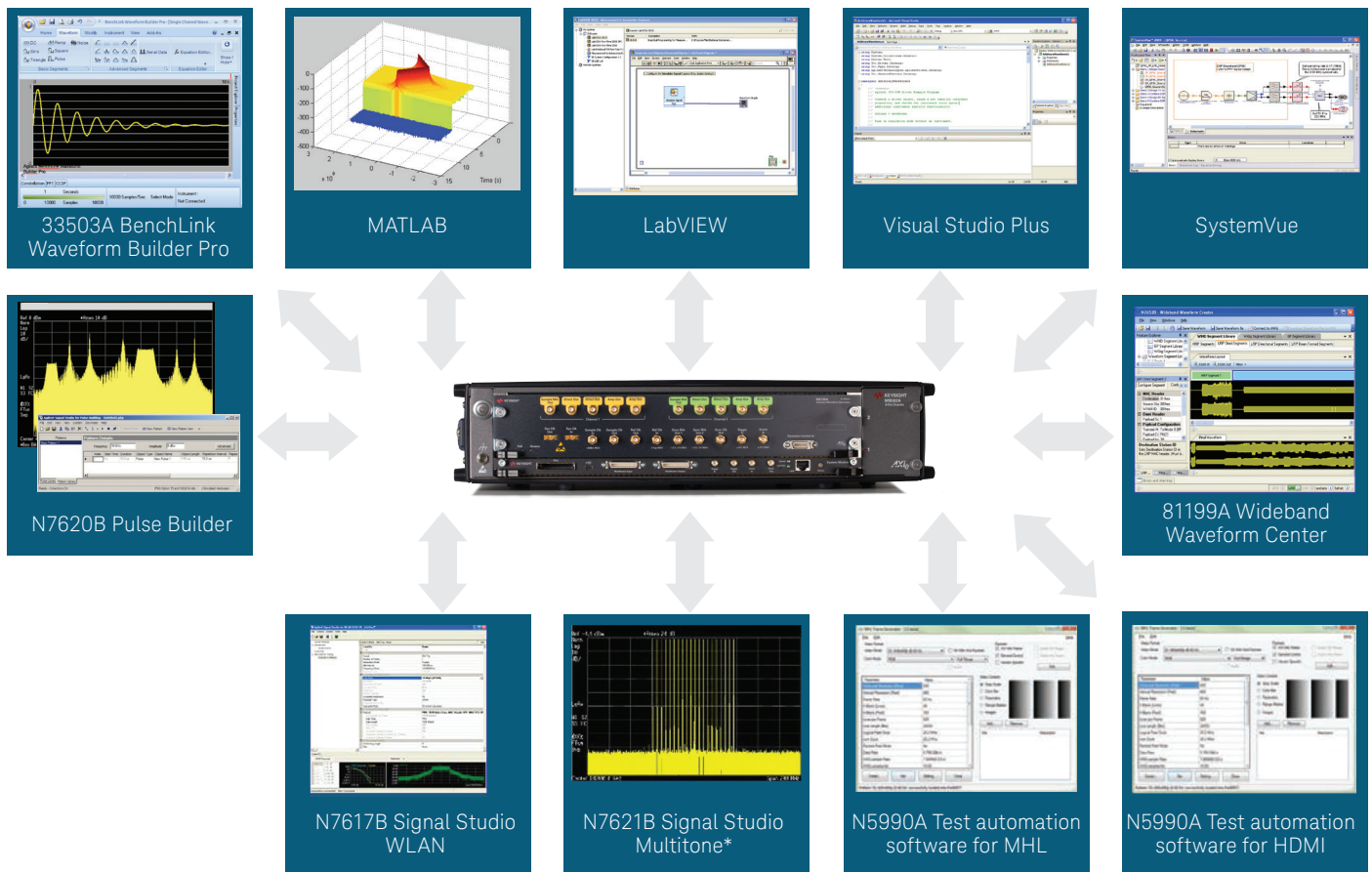

*Planned

Memory

Highly realistic testing often requires long play times and long signal scenarios

For example, 2 GSa of memory combined with advanced sequencing capabilities allow you to use the memory efficiently and effectively.

For sensitive applications, memory storage is not persistent: Memory contents are volatile and are erased when power is turned off.

Direct access to individual memory segments is possible in real time through the dynamic sequence control input. You can create waveforms and download them into the M8190A using software applications such as Signal Studio Pulse Builder, Multi-tone and WLAN; SystemVue, MATLAB, LabView or your own routines written in C++, C# or Visual Basic.

Configure

Assemble the best configuration for your application

The typical test setup shown to the right covers high RF applications up to 40 or 60 GHz. In this case the M8190A generates differential I/Q signals that are sent to an upconverter such as the Keysight PSG signal generator. The M8190A is packaged in the AXIe form factor, which reduces system size, weight and footprint.

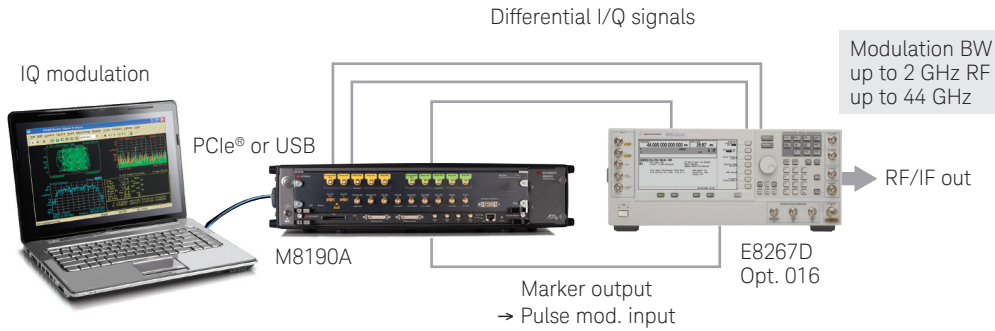

The block diagrams shown to the right illustrate configurations for I/Q modulation and direct IF/RF output. The M8190A supports direct generation of IF signals: Because this is done digitally, signal quality is outstanding. The instrument provides an analog bandwidth of 5 GHz; if higher output frequency is needed a mixer must be added to the configuration.

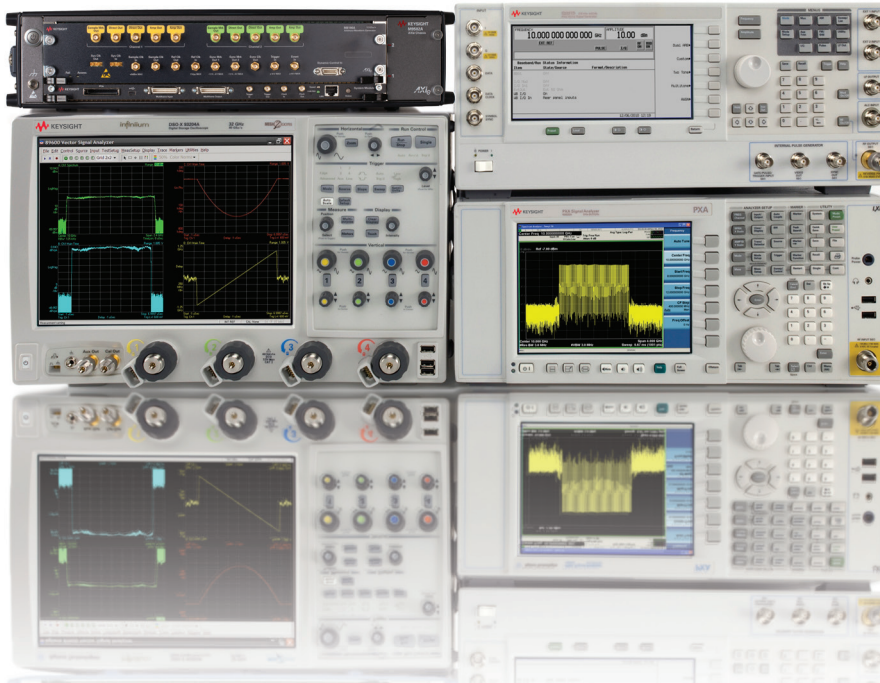
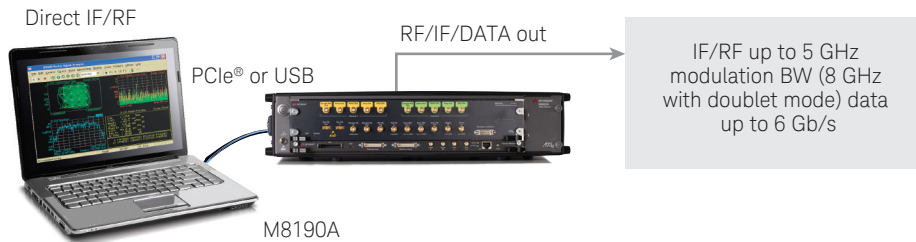

Multi-Level Signals

Jitter and noise cause misalignment of edges and levels, resulting in data errors.

The M8190A is equipped to ensure flexible modifications to fit new distortion requirements by simply adapting the waveform itself. You can easily mimic analog imperfections that occur in real-world environments by using mathematical description in tools such as MATLAB. This minimizes the need for additional hardware while preserving the ability to create realistic signal simulations.

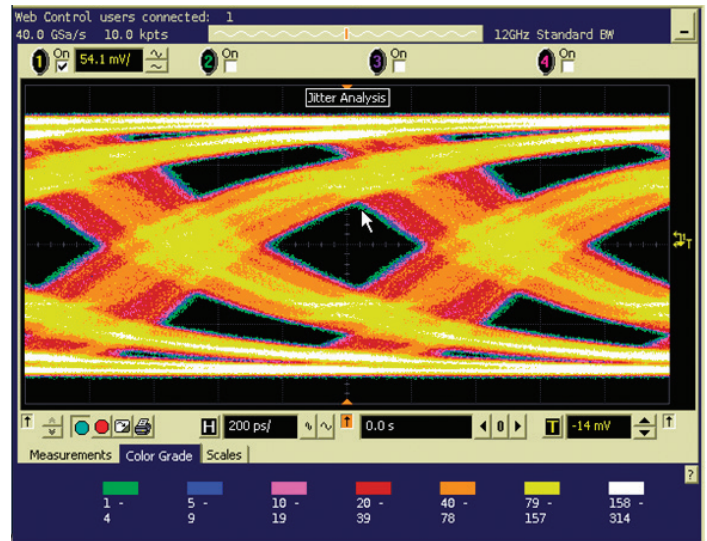
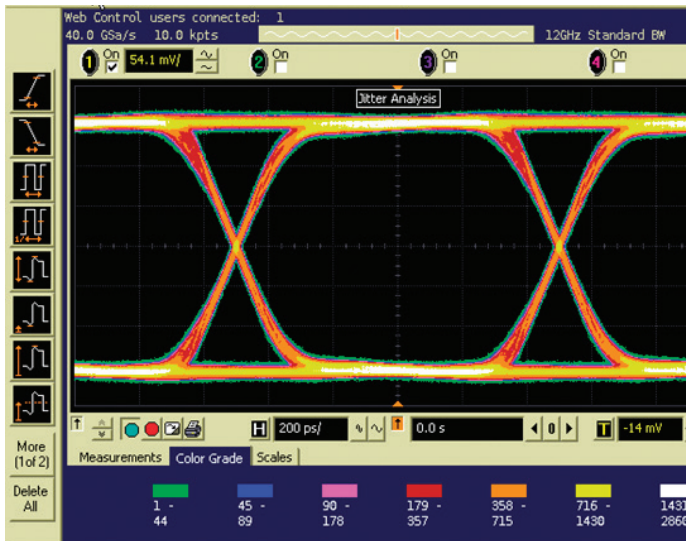
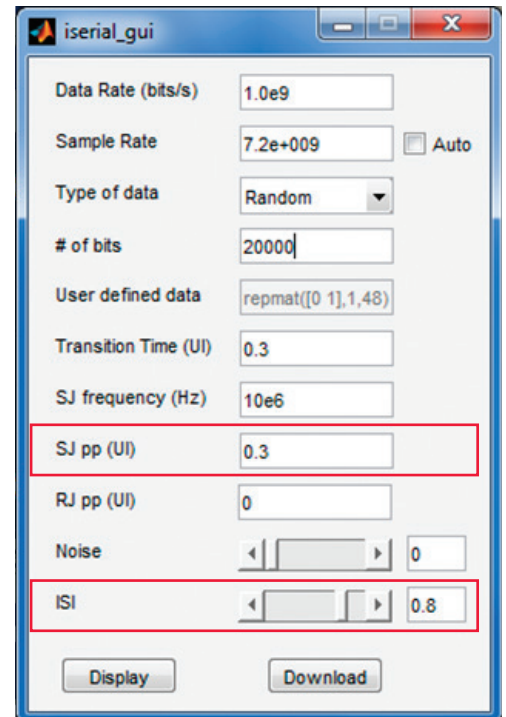

Generate multi-level signals with programmable ISI and jitter up to 6 Gb/s.

Scenarios

In aerospace and defense, technology is evolving to wider bandwidths without compromising on resolution.

The foundation is digital technology, which is becoming more prevalent because it provides advantages such as reduced size, lower power requirements, better calibration and faster volume scans.

When developing radar systems, real-life testing is very expensive. Simulations with highly realistic signals help reduce the cost of system testing. The Keysight M8190A addresses these needs with three key capabilities: wide bandwidth, high resolution and long play times.

Real-time digital signal processing with Keysight proprietary ASIC

Digital up-conversion takes testing one step further. The wide bandwidth allows generating the IF signal directly. The IQ data will be upconverted digitally in hardware which gives you best signal quality in the desired frequency range. The frequency resolution is very precise with sample clock down to the picosecond range. In addition efficient memory usage allows to extend the playtime by up to 1 million times. For example for a radar signal the waveform needs to be stored only once and amplitude, frequency and phase are stored independently. Precise carrier frequency, phase and amplitude settings is possible in real-time under sequencer control. Even complex operations such as frequency sweep are possible. Streaming functionality is available for infinite playtime. Endless scenarios can be played.

Push radar and electronic warfare designs farther with highly realistic signal scenarios

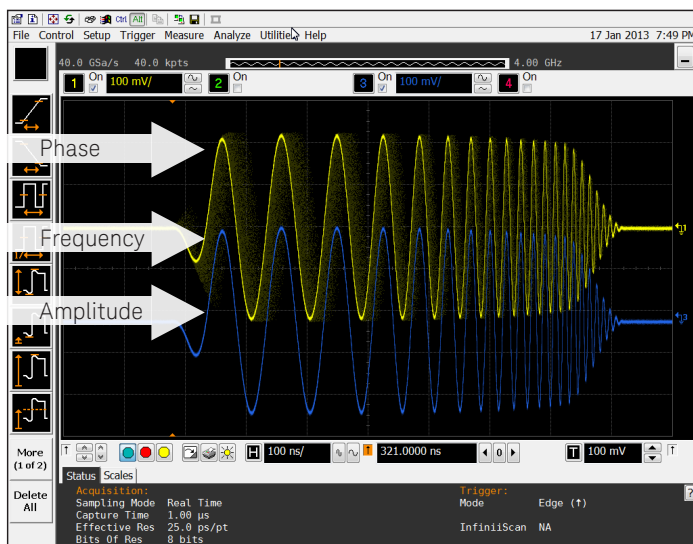

Radar chirp with phase changes on the fly

Infinite Playtime

Streaming and memory ping pong

While up to 2G Samples of waveform memory and a powerful sequencing engine provide sufficient playtime for most cases, there are some applications, such as radar scenario simulations, where playtimes in the order of several minutes are required.

In another class of applications, the number of possible waveform segments is too large to be pre-loaded into the waveform memory. An example might be NPR measurement where thousands of waveform combinations are required to cover all test cases and the signal must not be interrupted.

To address these applications, the M8190A offers the unique capability to download waveforms into portions of the waveform memory while the generator is running. In its simplest form, two waveform segments (A and B) are defined and while the generator outputs segment A repetitively, software can update segment B. Using a software command, the generator switches over to output segment B and while B is output, segment A can be overwritten and so on. This functionality is often referred to as “memory ping pong”.

Taking this a step further, the waveform memory can be split up into a certain number (≥ 5) of waveform segments which are linked together as a ring buffer (i.e. $A \rightarrow B \rightarrow C \rightarrow D \rightarrow E \rightarrow A \rightarrow B$, etc.). The generator sequentially outputs each waveform segment and as soon as it proceeds to the next one, the software loads a new waveform into this segment. This mode of operation is referred to as streaming.

In continuous streaming mode, the generator proceeds from one segment to the next without any pauses. Obviously, this mode requires the software and controlling PC to deliver new waveform segments fast enough to keep up with the rate that the waveforms are output.

In triggered streaming mode, the generator proceeds to the next segment upon an internal or external trigger event. This mode is particularly useful for pulsed radar simulations, where short pulses are interleaved with long pauses with a certain on/off ratio. Depending on the on/off ratio, the required throughput for waveform download can be dramatically reduced (resp. the output bandwidth during pulse on-time increased).

Streaming works best in conjunction with Digital Up-conversion Mode, because the baseband information can be provided at a much lower sample rate – independent of the carrier frequency.

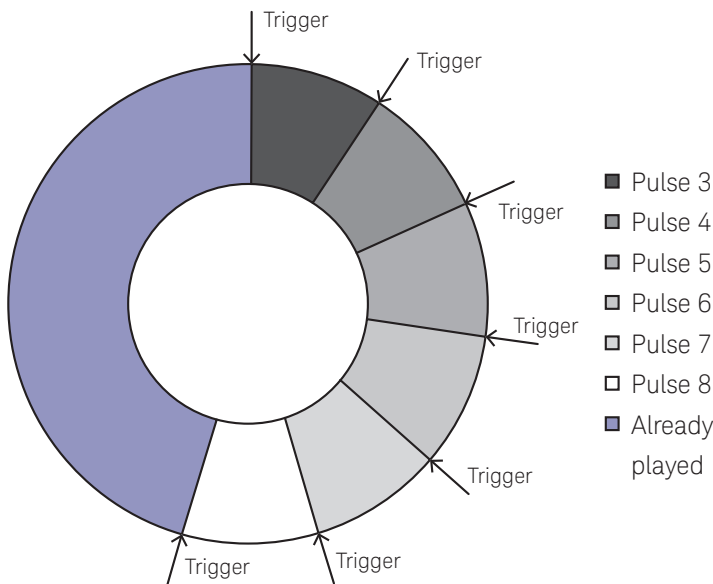

Infinite Playtime (Continued)

Data sources

Waveform data for streaming can be retrieved from a number of sources:

- Harddisk – typically a fast RAID drive or Solid State Drive (SSD), which offers sufficient data throughput for continuous streaming.
- Algorithmically generated – typically a pre-calculated set of waveforms that are available in PC memory. User software can select which waveform is used at which point in time.
- From Digitizer – to realize capture/replay scenarios.

Throughput and achievable bandwidth

For continuous streaming, the hardware and software on the controlling PC must be able to deliver data fast enough to keep up with waveform generation. On a high-end PC, a throughput of 500 – 600 MByte/s are achievable. In Digital Up-conversion mode, this corresponds to a modulation bandwidth of 125 to 150 MHz (4 bytes per I/Q sample pair). In triggered streaming mode, approx. 2 GHz modulation bandwidth can be achieved. This is the maximum that can be achieved in DUC mode – depending on the on/off ratio of the signal (please refer to publication no. 5991-3937EN).

Availability

The memory ping-pong and streaming functionality is available starting with M8190A firmware Rev. 3.0. An example program in C++ (both source and executable) is provided with the firmware installation that realizes the streaming functionality.

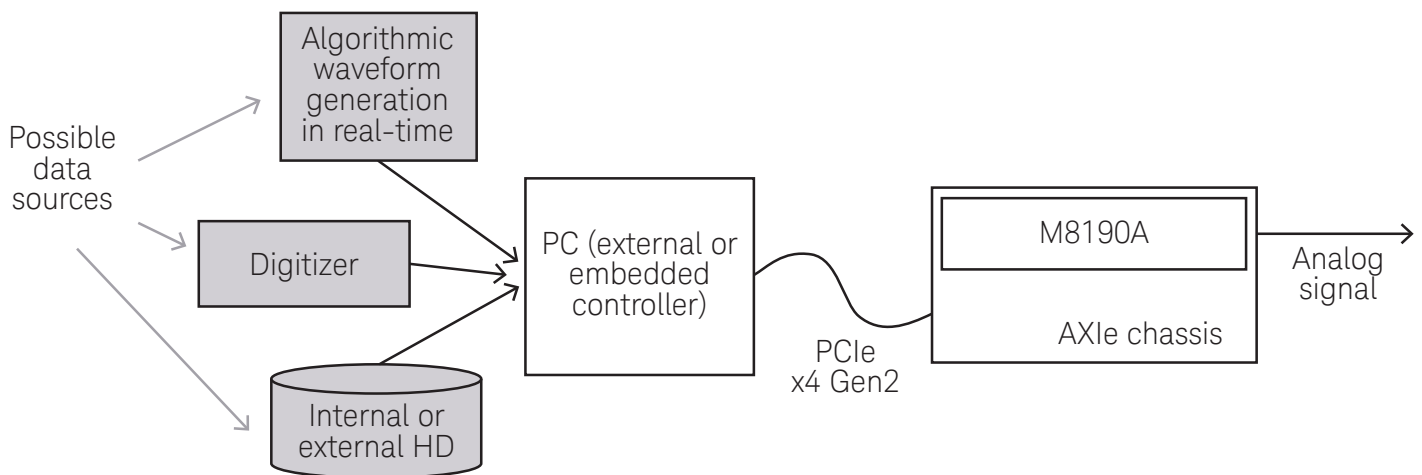

Headroom

Accurate emulation of transmissions—from ground station to airborne transceiver to distant ground station—includes interference, fading and more.

High numbered digital modulations transport more data in the same bandwidth, but tend to produce inaccurate levels and phase angles. Detailed testing becomes very important.

As a result, it is necessary to create high-quality signals with 14-bit resolution SFDR less than -90 dBc. This excellent SFDR ensures that tones stand out from distortion, even with hundreds of tones. The 2 GSa memory ensures that you can store more than one signal scenario and simply switch between segments via direct memory access and the dynamic sequence control input.

The M8190A gives you the versatility to define new signals—proprietary, next-generation and beyond. The 5 GHz modulation bandwidth gives you enough headroom to test and address next-generation modulation schemes.

Build a strong foundation for highly reliable satellite communications

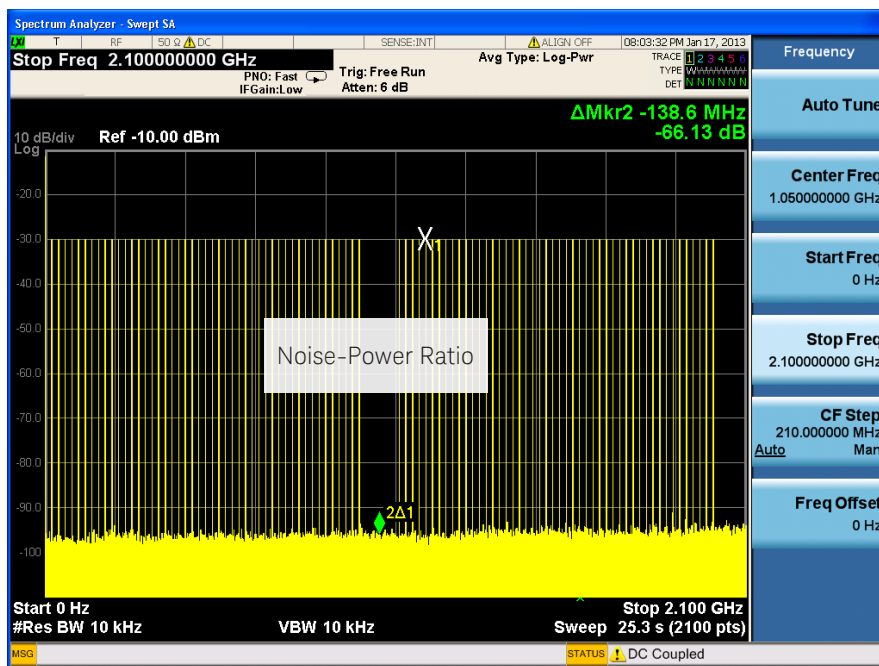

Multi-tone signal – 100 tone from 0 to 2.1 GHz ($F_s = 7.2$ GHz, $\sin(x)/x$ compensated).

Product Structure

The AWG has a modular product structure and requires an AXIe chassis (please see page 13).

M8190A	Option	Software upgradeable	Comment
1 channel	001		MUST order either 001 or 002 or LPN (requires customer-provided external clock source)
2 channel	002		
2 channels with low phase noise	LPN		
14 bit/8 GSa/s ¹	14B	X	MUST order either 14B or 12G or both options
12 GSa/s/12 bit ¹	12G	X	
Additional DC and AC amplifier ¹	AMP	X	
Digital up-conversion to carrier frequency ¹	DUC	X	
Upgrade from 128 MSa to 2 GSa memory per channel	02G	X	2 channel version requires Option 02G (quantity 2)
Sequencer ^{1,2}	SEQ	X	
Fast switching ¹	FSW	X	Fast switching for 12 GSa/s
ISO 17025	1A7		Calibration options
Z540	Z54		

1. Only quantity 1 is required for 2 channel version.

2. Option FSW does not affect switching time in 14 bit mode (Option 14B).

Bundles including AXIe chassis are available under:

- M8190A -BU1 5 slot chassis, with embedded PC 16 GB RAM and Windows Embedded Standard 7 operating system: 64 bit
- M8190A -BU2 2 slot chassis (connectivity accessories will be added automatically - choice between desktop and laptop cabling)
- M8190S Multichannel Arbitrary Waveform Generator System (4- & 8 channels are selectable)

Accessories

Model name	Description
M8190A-801	Microwave phase matched balun, 6.5 GHz, max SMA jack
M8190A-805	Low pass filter, 2800 MHz, max SMA, VLF 2850+
M8190A-806	Low pass filter, 3900 MHz max SMA, VLF 3800+
M8190A-810	Cable assembly coaxial-50 Ω, SMA to SMA, 457 mm length
M8190A-811	Cable assembly coaxial-50 Ω, SMA to SMA, 1220 mm length
M8190A-815	Dynamic control input cable
M8190A-820	Connector-RF, SMA termination, plug straight, 50 Ω, 12.4 GHz, 0.5 W

The Instrument

Challenge the Boundaries of Test Keysight Modular Products



Two slot AXle chassis with M8190A AWG.



Five slot AXle chassis with two M8190A AWG; can contain an embedded controller.

AXIe

The M8190A is a modular instrument packaged in the AXIe form factor. AXIe is a new open standard for high-performance, modular instrumentation, and incorporates the best features of other modular formats including VXIbus, LXI and PXI. Keysight offers a line of scalable chassis in this powerful format. Along with controller options, these AXIe chassis can form the basis of high-performance, AXIe-based test systems.

Two form factors are available: two-slot and five-slot chassis. These include an embedded AXIe system module that does not occupy a module slot. In addition, an AXIe controller is an entire system that can control the AWG. This controller consumes one module slot in the chassis.

The chassis can be used on the bench or in a rack, occupying only 4U of rack space. Keysight computer I/O cards are also available for AXIe systems.

- M9502A-U20: 2-slot AXIe chassis with USB option
- M9505A-U20: 5-slot AXIe chassis with USB option
- M9048A: PCIe desktop card adapter Gen 2 x8
- Y1200B: x4 – x8 PCIe cable
- Y1202A: x8 – x8 PCIe cable
- M9537A: Embedded AXIe controller
- M8192A Multi-Channel Synchronization Module for M8190A AWG

Performance Specification

General characteristics	
Digital to analog converter	
- Option: -14B	Resolution 14 bit
	Sample rate 125 MSa/s to 8 GSa/s
- Option: -12G	Resolution 12 bit
	Sample rate 125 MSa/s to 12 GSa/s
Sin (x)/x roll-off (mathematically calculated)	
- Option: -14B	Sin (x)/x (-1 dB) 2.1 GHz at 8 GSa/s
	Sin (x)/x (-3 dB) 3.5 GHz at 8 GSa/s
- Option: -12G	Sin (x)/x (-1 dB) 3.1 GHz at 12 GSa/s
	Sin (x)/x (-3 dB) 5.3 GHz at 12 GSa/s
Frequency switching characteristics	
Effective output frequency (f_{\max} is determined as $f_{\text{Sa,max}}/2.5$)	
- Option: -14B	$f_{\max} = 3.2$ GHz
- Option: -12G	$f_{\max} = 4.8$ GHz
Effective frequency switching time ¹	
- Option: -14B with or without FSW	313 ps (= $1/f_{\max}$)
- Option: -12G without FSW	105 μ s to 210 μ s
- Option: -12G with FSW	208 ps (= $1/f_{\max}$)
Direct out1/direct out2	
Type of output	Single-ended ² or differential, DC-coupled
Skew between normal and complement outputs	0 ps (nom)
Skew accuracy between normal and complement outputs	± 5 ps (typ)
Impedance	50 Ω (nom)
Amplitude control	Specified into 50 Ω
- Range, single-ended (DNRZ/NRZ mode) ³	350 mV _{p-p} to 700 mV _{p-p}
- Resolution	30 μ V (nom)
- DC accuracy, offset = 0 V (DNRZ/NRZ mode) ³	$\pm (1.5\% + 15$ mV) (spec)
Offset	-20 mV to + 20 mV, single-ended into 50 Ω
Offset resolution	60 μ V (nom)
DC offset accuracy	± 10 mV (spec)
	Common mode offset and differential offset is separately adjustable
Connector type	SMA

1. Determines the minimum time needed to switch between selected segments in sequence mode.
2. Unused output must be terminated with 50 Ω to GND.
3. Doublet mode does not allow DC signal generation.

Performance Specification (Continued)

NRZ/DNRZ mode	
Bandwidth (3 dB) ¹	3.0 GHz (typ)
Bandwidth (5 dB)	5.0 GHz (typ)
Harmonic distortion 7.2 GSa/s ^{2,4}	-72 dBc (typ), $f_{out} = 100$ MHz
	-68 dBc (typ), $f_{out} = 10$ MHz ... 200 MHz, measured DC to 3 GHz
	-60 dBc (typ), $f_{out} = 200$ MHz ... 3000 MHz, measured DC to 3 GHz
Harmonic distortion 12 GSa/s ^{3,4}	-54 dBc (typ) $f_{out} = 100$ MHz
	-50 dBc (typ) $f_{out} = 10$ MHz ... 5000 MHz, measured DC to 5 GHz
SFDR in 14 bit mode ^{2,4} (excluding harmonic distortion)	In band performance:
	-90 dBc (typ), $f_{out} = 100$ MHz, measured DC to 2 GHz
	-80 dBc (typ), $f_{out} = 10$ MHz...500 MHz, measured DC to 500 MHz
	-76 dBc (typ), $f_{out} = 500$ MHz...1 GHz, measured DC to 1 GHz
	-68 dBc (typ), $f_{out} = 1$ GHz...2 GHz, measured DC to 2 GHz
	-62 dBc (typ), $f_{out} = 2$ GHz...3 GHz, measured DC to 3 GHz
	Adjacent band performance:
	-80 dBc (typ), $f_{out} = 10$ MHz...500 MHz, measured DC to 1.5 GHz
	-73 dBc (typ), $f_{out} = 500$ MHz...1 GHz, measured DC to 3 GHz
	-68 dBc (typ), $f_{out} = 1$ GHz...2 GHz, measured DC to 3 GHz
-62 dBc (typ), $f_{out} = 2$ GHz...3 GHz, measured DC to 3 GHz	
SFDR in 12 bit mode ^{3,4} (excluding harmonic distortion)	In band performance:
	-90 dBc (typ), $f_{out} = 100$ MHz, measured DC to 2 GHz
	-80 dBc (typ), $f_{out} = 10$ MHz...500 MHz, measured DC to 500 MHz
	-78 dBc (typ), $f_{out} = 500$ MHz...1 GHz, measured DC to 1 GHz
	-73 dBc (typ), $f_{out} = 1$ GHz...2 GHz, measured DC to 2 GHz
	-68 dBc (typ), $f_{out} = 2$ GHz...3 GHz, measured DC to 3 GHz
	-60 dBc (typ), $f_{out} = 3$ GHz...5 GHz, measured DC to 5 GHz
	Adjacent band performance:
	-80 dBc (typ), $f_{out} = 10$ MHz...500 MHz, measured DC to 1.5 GHz
	-73 dBc (typ), $f_{out} = 500$ MHz...1 GHz, measured DC to 3 GHz
-68 dBc (typ), $f_{out} = 1$ GHz...2 GHz, measured DC to 5 GHz	
-64 dBc (typ), $f_{out} = 2$ GHz...3 GHz, measured DC to 5 GHz	
-60 dBc (typ), $f_{out} = 3$ GHz...5 GHz, measured DC to 5 GHz	
Two-tone IMD ²	TTIMD = -73 dBc (typ), $f_{out1} = 499.5$ MHz, $f_{out2} = 500.5$ MHz

1. t_r bandwidth: $BW = 0.25/t_r$.

2. SCLK = 7.2 GSa/s, amplitude = 700 mV_{p-p}, double NRZ mode, excluding $f_{sa} - 2 * f_{out}$, $f_{sa} - 3 * f_{out}$.

3. SCLK = 12 GSa/s, amplitude = 700 mV_{p-p}, double NRZ mode, excluding $f_{sa} - 2 * f_{out}$, $f_{sa} - 3 * f_{out}$.

4. Measured with a balun such as the HL9402 from Hyperlabs plus 10 dB attenuator.

Performance Specification (Continued)

ENOB vs. frequency

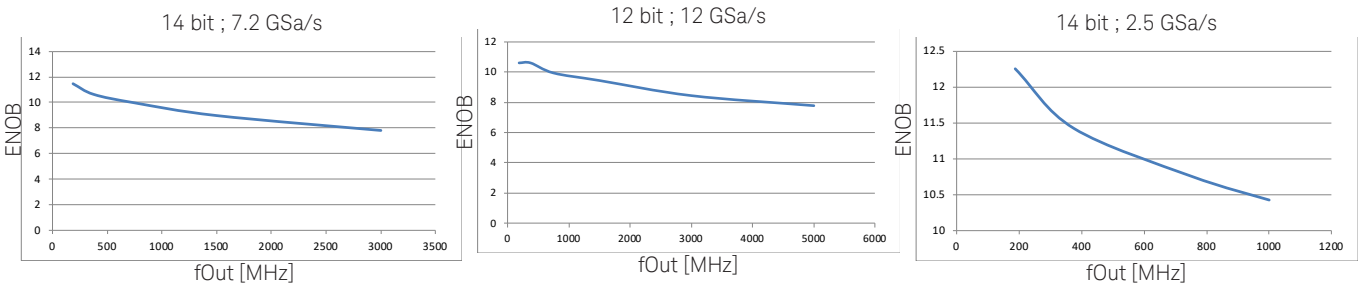

Doublet mode

Bandwidth	See frequency plot (measured) 8 GHz/12 GHz, single ended
Harmonics 14 bit doublet mode ¹ 8 GSa/s	$f_{out} = 5400 \text{ MHz} \dots 6500 \text{ MHz}$ measured 5.4 GHz to 6.5 GHz, no harmonics in this range
Harmonics 12 bit doublet mode ² 12 GSa/s	$f_{out} = 8100 \text{ MHz} \dots 9900 \text{ MHz}$, measured 8.1 GHz to 9.9 GHz, no harmonics in this range
SFDR in 14 bit doublet mode ¹ 8 GSa/s (excluding harmonic distortion)	-48 dBc (typ) $f_{out} = 5400 \text{ MHz} \dots 6500 \text{ MHz}$, measured 5.4 GHz to 6.5 GHz, Single ended
SFDR in 12 bit doublet mode ² 12 GSa/s (excluding harmonic distortion)	-44 dBc (typ) $f_{out} = 8100 \text{ MHz} \dots 9900 \text{ MHz}$, measured 8.1 GHz to 9.9 GHz, Single ended

1. SCLK = 8 GSa/s, amplitude = 700 mV_{p-p}, double NRZ mode, excluding $f_{Sa} - 2 * f_{out}$, $f_{Sa} - 3 * f_{out}$.
2. SCLK = 12 GSa/s, amplitude = 700 mV_{p-p}.

Frequency Response, includes sin x/x roll-off (typ.)

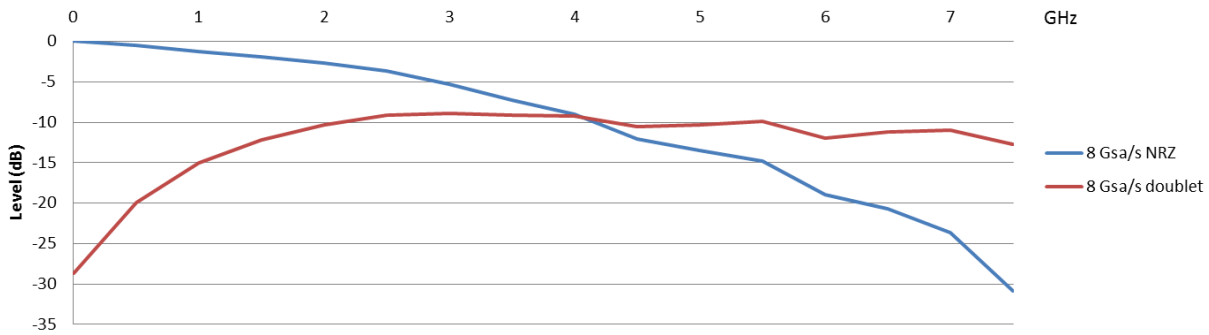

Frequency Response, includes sin x/x roll-off (typ.)

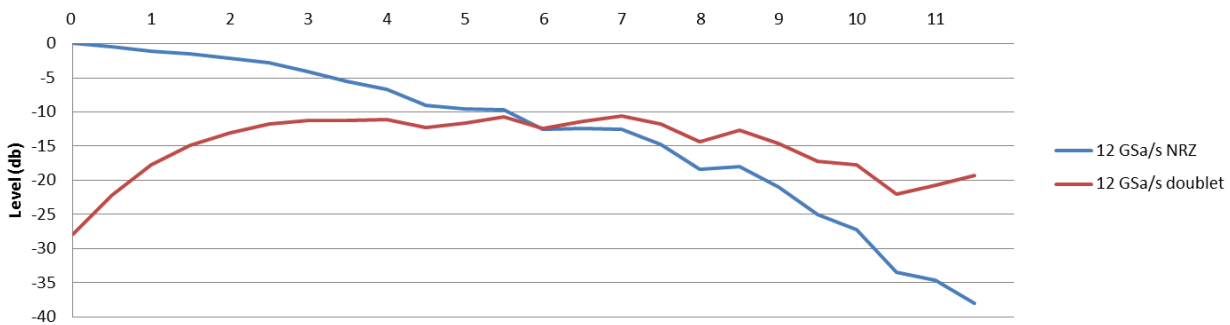

Performance Specification (Continued)

Two selectable output paths per channel are available when Option AMP is installed: 1) DC output path 2) AC output path.

Amp out1/amp out2	
DC output	
Output type	Single-ended ¹ or differential, DC-coupled
Impedance	50 Ω (nom)
Amplitude	500 mV _{pp} to 1.0 V _{pp} , single-ended into 50 Ω
Amplitude resolution	300 μ V (nom)
DC amplitude accuracy	\pm (2.5% + 10 mV) (nom) ²
Voltage window	-1.0 V to +3.3 V ³ , single-ended into 50 Ω
Offset resolution	600 μ V (nom)
DC offset accuracy	\pm 2.5% \pm 10 mV (typ) \pm 4% of amplitude (typ) ⁴
Termination voltage window	-1.5 V to +3.5 V ³
Termination voltage resolution	300 μ V (nom)
Skew between normal and complement outputs	0 ps (nom)
Skew accuracy between normal and complement outputs	\pm 5 ps (typ)
Rise/fall time (20 to 80%)	< 60 ps (typ) ⁵
Jitter (peak-peak)	15 ps (typ) ⁵
Overshoot	5% (typ) ⁶
Connector type	SMA

1. Unused output must be terminated with 50 Ω to the termination voltage.
2. Termination voltage = 0 V; adjusted at 23 $^{\circ}$ C ambient temperature, amplitude reduces by 2 mV/ $^{\circ}$ C (typ) for ambient temperature above 23 $^{\circ}$ C, amplitude increases by 5 mV/ $^{\circ}$ C (typ) for ambient temperature below 23 $^{\circ}$ C³.
3. Termination voltage window: offset \pm 1 V.
4. Termination voltage = 0 V.
5. PRBS 2¹¹ - 1, f_{sa} = 12 GSa/s, data rate = 3 Gb/s, triggered on sample clock out, NRZ mode.

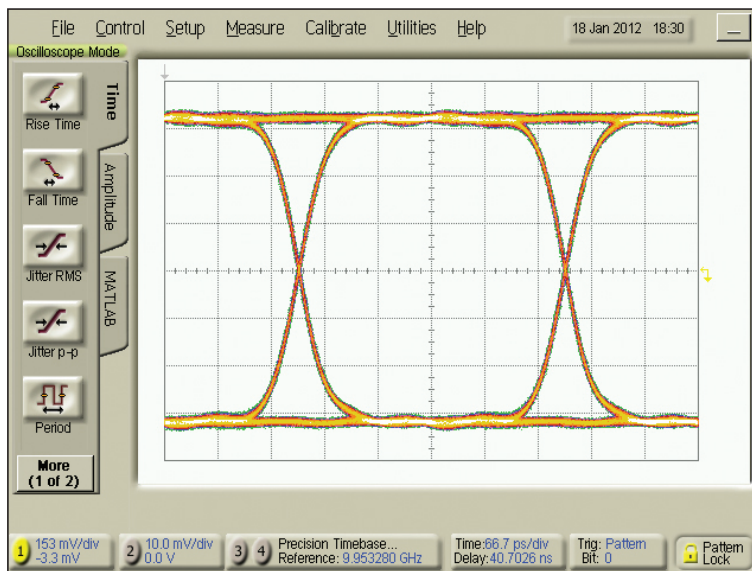

Eye pattern with amplitude 1000 mV with 0 V offset.

Performance Specification (Continued)

AC output	
Output type	Single-ended, AC coupled Front-panel marking: amp out1 for channel 1; amp out2 for channel 2
Impedance	50 Ω (nom)
Amplitude	200 mV _{pp} to 2.0 V _{pp} ¹ , single-ended into 50 Ω
Amplitude resolution	0.25 dB (nom)
Amplitude accuracy	± 0.5 dB ¹ (typ)
Bandwidth (3 dB)	50 MHz to 5 GHz (typ)
Harmonic distortion ²	< -39 dBc (typ), f _{out} = 375 MHz, measured DC to 3 GHz < -37 dBc (typ), f _{out} = 100 MHz ... 3000 MHz, measured 100 MHz to 3 GHz
Harmonic distortion ³	< -39 dBc (typ) f _{out} = 375 MHz, measured DC to 5 GHz < -37 dBc (typ) f _{out} = 100 MHz ... 5000 MHz, measured DC to 5 GHz
SFDR in 14 bit mode ² (excluding harmonic distortion) ⁵	< -60 dBc (typ), f _{out} = 100 MHz ... 2000 MHz, measured 100 MHz to 3000 MHz < -56 dBc (typ), f _{out} = 2000 MHz ... 3000 MHz, measured 100 MHz to 3000 MHz
SFDR in 12 bit mode ³ (excluding harmonic distortion)	< -60 dBc (typ), f _{out} = 100 MHz ... 2000 MHz, measured 100 MHz to 5000 MHz < -56 dBc (typ), f _{out} = 2000 MHz ... 3000 MHz, measured 100 MHz to 5000 MHz < -50 dBc (typ), f _{out} = 3000 MHz ... 5000 MHz, measured 100 MHz to 5000 MHz
Amplitude flatness ⁴	100 MHz to 1 GHz (typ), + 1.5 dB to -0.5 dB 100 MHz to 4 GHz (typ) ± 0.1 dB with calibration / pre-distortion 1 GHz to 4 GHz (typ), -2 dB to + 3 dB
Two-tone IMD ²	TTIMD = -46 dBc (typ), f _{out1} = 999.5 MHz, f _{out2} = 1000.5 MHz
Connector type	SMA

1. 500 MHz sine wave.

2. SCLK = 7.2 GSa/s, amplitude = 1 V_{p-p}, 14 bit mode, double NRZ mode, excluding f_{Sa} - 2*f_{out}, f_{Sa} - 3*f_{out}.

3. SCLK = 12 GSa/s, amplitude = 1 V_{p-p}, 12 bit mode, double NRZ mode, excluding f_{Sa} - 2*f_{out}, f_{Sa} - 3*f_{out}.

4. SCLK = 12 GSa/s, amplitude = 1 V_{p-p}; normalized to 100 MHz; 12 bit mode, includes sin(x)/x compensation.

5. SFDR numbers for interpolation mode are the same as the SFDR numbers for 14 bit mode. For further specification please see the digital up-conversion specification.

Performance Specification (Continued)

Marker outputs	
Number of markers	Two markers per channel
	– Sample marker
	– Sync marker
Output type	Sample marker: Single-ended Sync marker: Single ended
Sync marker out1/sync marker out 2	
Output impedance	50 Ω (nom)
Timing resolution ¹	N sample clock cycles (N = 64 in 12 bit mode; N = 48 in 14 bit mode)
Level	
– Voltage window	–0.5 V to 2.0 V
– Amplitude	200 mV _{pp} to 2.0 V _{pp}
– Resolution	10 mV
– Accuracy	\pm (10% + 25 mV) (typ)
Rise/fall time (20 to 80%)	150 ps (nom)
Width ¹	User-defined in multiples of N sample clock cycles (N = 64 in 12 bit mode; N = 48 in 14 bit mode)
Connector type	SMA
Sample marker out1/sample marker out 2	
Timing resolution ¹	1 sample clock cycle
Level	
– Voltage window	–0.5 V to 2.0 V
– Amplitude	200 mV _{pp} to 2.0 V _{pp}
– Resolution	10 mV
– Accuracy	\pm (10% + 25 mV) (typ)
Rise/fall time (20 to 80%)	150 ps (nom)
Width	49 sample clocks in 12 bit mode 40 sample clocks in 14 bit mode
Random jitter	5 ps RMS (typ)
Connector type	SMA

1. See characteristics digital up-conversion if interpolation is enabled.

Performance Specification (Continued)

A common trigger/gate input for both channels is provided on the front panel. This input is used to start a sequence or a scenario.

Trigger/gate and event input	
Input range	-5 V to +5 V
Threshold	
– Range	-5 V to +5 V
– Resolution	100 mV
– Sensitivity	200 mV
Polarity	Selectable positive or negative
Drive	Selectable channel 1, channel 2 or both
Input Impedance	1 k Ω or 50 Ω (nom), DC coupled
Max toggle frequency	
– 12 bit mode	Sample clock output frequency divided by 320
– 14 bit mode	Sample clock output frequency divided by 240
Minimum pulse width	
Asynchronous timing between trigger/gate and sync clock output	1.1 * sync clock period
Synchronous timing between trigger/gate input and sync clock output	See set-up and hold timing under timing characteristics
Connector type	SMA

Performance Specification (Continued)

A common dynamic control input for both channels is provided on the front panel. The user can select, if the dynamic control input affects none, only channel 1/channel 2 only, or both channels. A detailed description of the dynamic control input including timing diagram and pin assignment is shown in the *M8190A User's Guide*.

Dynamic control input	
Input signals	Data[0..12]_In + Data_Select + Load ¹
Internal data width	19 bit, multiplexed using Data_Select
Data_Select	Data_Select = Low: Data[0..12] = Data[0..12]_In Data_Select = High: Data[13..18] = Data[0..5]_In
Number of addressable segments or sequences	2 ¹⁹ = 524 288
Data rate	DC to 1 MHz
Set-up time	3.0 ns ('Data[0..12]_In, 'Data_Select' to rising edge of 'Load')
Hold time	0.0 ns (rising edge of 'Load' to 'Data[0..12]_In, 'Data_Select')
Minimum ³ latency ⁴	Dynamic control input to direct out
– 12 bit mode	27520 sample clock cycles (meas)
– 14 bit mode	20640 sample clock cycles (meas)
Interpolation mode ⁵	
Input range	
– Low level	0 V to +0.7 V
– High level	+1.6 V to +3.6 V
Impedance	Internal 1 kΩ pull-down resistor to GND
Connector	20 pin mini D ribbon (MDR) connector ² , cable Option 815

1. Data[0...12]_In and 'Data_Select' will be stored on rising edge of 'Load signal.'

2. Manufacturer Part Number: N10220-52B2PC. Manufacturer: 3M.

3. As the current segment (or sequence or scenario) is always completed, the total latency is determined by the duration of the segment (or sequence or scenario). See characteristics of digital up-conversion if interpolation is enabled.

4. See characteristics digital up-conversion if interpolation is enabled.

Performance Specification (Continued)

The M8190A can operate synchronously or asynchronously. Synchronous operation must be selected to achieve minimum delay uncertainty between Trigger Input, Event, Input or Dynamic Control Input and Direct Out or Marker Out. For synchronous operation Trigger/Gate Input, Event, Input or Dynamic Control must be synchronous to the Sync Clock Output.

Timing characteristics	
Setup time	
- Trigger/gate in to rising edge of sync clock out	10.5 ns (typ)
- Event in to rising edge of sync clock out	10.5 ns (typ)
Hold time	
- Rising edge of sync clock out to trigger/gate in	-7.5 ns (typ)
- Rising edge of sync clock out to event in	-7.5 ns (typ)
Delay in 12 bit mode	
- Trigger/event in to direct/DC/AC out	10240 external sample clock cycles + 0.5 internal ¹ sample clock cycles (nom)
- Sync marker to direct/DC/AC out	0.5 internal ¹ sample clock cycles - 4.9 ns (nom) (fSa >= 6.4 GSa/s)
	0.5 internal ¹ sample clock cycles - 8.0 ns (nom) (fSa < 6.4 GSa/s)
Delay in 14 bit mode	
- Trigger/event in to direct/DC/AC out	7680 external sample clock cycles + 0.5 internal ¹ sample clock cycles (nom)
- Sync marker to direct/DC/AC out	0.5 internal ¹ sample clock cycles - 4.9 ns (nom) (fSa >= 4.8 GSa/s)
	0.5 internal ¹ sample clock cycles - 8.0 ns (nom) (fSa < 4.8 GSa/s)
Sample marker to direct/DC/AC out	0.5 internal ¹ sample clock cycles - 1.3 ns (nom)
Delay uncertainty	
Asynchronous mode	64 external sample clocks in 12 bit mode
	48 external sample clocks in 14 bit mode
Synchronous mode	10 ps (typ) ²

1. Internal sample clock cycles. For definition of 'Internal sample clock cycles' refer to sample clock outputs specification.

2. The delay accuracy in synchronous mode is equal to the peak-peak jitter between sync clock output and direct out.

Note: Timing characteristics of DUC, see digital up-conversion (DuC) chapter.

Performance Specification (Continued)

Variable delay

In order to compensate for e.g. external cable length differences as well as the initial skew, channel 1 and channel 2 can be independently delayed with a very high timing resolution.

Setting the variable delay of channel 1 to 10 ps has following effect:

- Direct out1 (or amp out1, if selected) and sample marker out1 are delayed by 10 ps with respect to following signals: sample clock out, sync marker out1, sync marker out2, direct out2 (or amp out2, if selected), trigger/gate input, event input

Note: Modifying the variable delay of one channel always affects the delay of the analog output AND the sample marker of that channel.

The variable delay is split into two delay elements:

1. Fine delay
2. Coarse delay

The variable delay is the sum of fine delay and coarse delay. If a de-skew between channel 1 and channel 2 is needed, adjust in the first step the coarse delay to the optimum position. In the second step, use the fine delay to perfectly align both channels.

Variable delay

Variable delay	Fine delay + coarse delay
Variable delay range	
– $f_{sa} \geq 6.25$ GSa/s	0 ps to 10.030 ns
– 2.5 GSa/s $\leq f_{sa} < 6.25$ GSa/s	0 ps to 10.060 ns
– $f_{sa} < 2.5$ GSa/s	0 ps to 10.150 ns

Fine delay

The fine delay is independently adjustable for channel 1 and channel 2

Delay range	
– $f_{sa} \geq 6.25$ GSa/s	– 0 ps to 30 ps
– 2.5 GSa/s $\leq f_{sa} < 6.25$ GSa/s	– 0 ps to 60 ps
– $f_{sa} < 2.5$ GSa/s	– 0 ps to 150 ps
Delay resolution	50 fs

Accuracy

– $f_{sa} \geq 6.25$ GSa/s	± 10 ps (typ)
– 2.5 GSa/s $\leq f_{sa} < 6.25$ GSa/s	± 20 ps (typ)
– $f_{sa} < 2.5$ GSa/s	± 20 ps (typ)

1. For definition of “internal sample clock cycles”, refer to sample clock output specification.

Note for delay in interpolation mode: Please see digital up-conversion specification.

Performance Specification (Continued)

Coarse delay

The coarse delay is independently adjustable for channel 1 and channel 2

Delay range	0 ps to 10 ns, variable
Delay resolution	
– $f_{sa} \geq 6.25$ GSa/s	10 ps
– 2.5 GSa/s $\leq f_{sa} < 6.25$ GSa/s	20 ps
– $f_{sa} < 2.5$ GSa/s	50 ps
Accuracy	
– $f_{sa} \geq 6.25$ GSa/s	± 20 ps (typ)
– 2.5 GSa/s $\leq f_{sa} < 6.25$ GSa/s	± 20 ps (typ)
– $f_{sa} < 2.5$ GSa/s	± 50 ps (typ)

When the variable delay is set to 0 ps, the channels operate in coupled mode and the same amplifier path for both channels is selected, the initial skew between channel 1 and channel 2 is 0 ps.

Initial skew between channel 1 and channel 2

Skew ¹	0 ps (nom)
Accuracy	± 20 ps (typ)

1. Coupling on, same amplifier path is selected for channel 1 and channel 2.

Performance Specification (Continued)

Reference clock output	
Source	Internal backplane 100 MHz
– Frequency	100 MHz
– Stability	± 20 ppm (typ.) (see M9502A/M9595A Data Sheet)
– Aging	± 1 ppm per year
Source	Internal Oven-Controlled Reference Oscillator
– Frequency	100 MHz
– Accuracy	± 0.2 ppm (typ.)
– Stability	± 0.6 ppm (typ.)
– Aging	± 0.3 ppm per year (typ.)
– Phase noise	–95 dBc/Hz at 10 Hz, –125 dBc/Hz at 100 Hz offset (typ.)
	Phase noise at offsets > 100 Hz (refer to phase noise plots on page 30)
Source	External REF CLK In
– Frequency	100 MHz
– Amplitude	1 V _{pp} into 50 Ω (nom)
– Source impedance	50 Ω, AC coupled (nom)
– Connector	SMA
Reference clock input	
Input frequencies	Selectable 1 MHz to 200 MHz, in steps of 1 MHz
Lock range	± 35 ppm (typ)
Frequency resolution	1 MHz
Input level	100 mV _{pp} to 2 V _{pp}
Impedance	50 Ω, AC coupled (nom)
Connector type	SMA
Sync clock output	
Frequency	
– 14 bit mode	Sample clock divided by 48 (sample clock source is always channel 1)
– 12 bit mode	Sample clock divided by 64 (sample clock source is always channel 1)
– Interpolation mode	Sample clock divided by (24 x interpolation factor)
Output amplitude	1.0 V _{pp} (nom) into 50 Ω
Impedance	50 Ω nominal, AC coupled
Connector	SMA

Performance Specification (Continued)

Sample clock

There are two selectable sources for the sample clock:

- Internal synthesizer
- Sample clock input

The two channel instrument (Option 002) offers the flexibility to independently select the sample clock sources for channel one and channel two. If different clock sources are selected for the channels, both channels operate entirely independently with respect to sample rate and sequencing.

Internal synthesizer clock characteristics

Frequency	125 MHz to 12 GHz
Accuracy	± 20 ppm
Frequency resolution	15 digits, e.g. 10 µHz at 1 GHz
Phase noise ¹	$f_{\text{Sa}} = 1 \text{ GHz} < -110 \text{ dBc/Hz (typ) at } 10 \text{ kHz offset, } f_{\text{out}} = 125 \text{ MHz}^2$
	$f_{\text{Sa}} = 8 \text{ GHz} < -105 \text{ dBc/Hz (typ) at } 10 \text{ kHz offset, } f_{\text{out}} = 1.0 \text{ GHz}^2$
	$f_{\text{Sa}} = 12 \text{ GHz} < -105 \text{ dBc/Hz (typ) at } 10 \text{ kHz offset, } f_{\text{out}} = 1.5 \text{ GHz}$

Sample clock input

Frequency range ¹	1 GHz to 12 GHz
Input power range	+0 dBm to +7 dBm
Damage level	+8 dBm
Input impedance	50 Ω nom, AC coupled
Connector type	SMA

1. The sample clock output is derived from the internal sample clock $f_{\text{Sa},i}$. For $f_{\text{Sa},i} = 500 \text{ MSa/s} \dots 1 \text{ GSa/s}$ the sample clock output is twice of $f_{\text{Sa},i}$. For $f_{\text{Sa},i} = 250 \text{ MSa/s} \dots 500 \text{ MSa/s}$ the sample clock output is four times $f_{\text{Sa},i}$. For $f_{\text{Sa},i} = 125 \text{ MSa/s} \dots 250 \text{ MSa/s}$ the sample clock output is eight times $f_{\text{Sa},i}$.
2. Measured at "data out".

Low Phase Noise clock input (only with option LPN)

Frequency range	1 GHz to 12 GHz
Input power range	+0 dBm to + 7 dBm
Damage level	+10 dBm
Input impedance	50 Ω nom, AC coupled
Transition time	< 1 ns
Connector type	SMA

- Configuring the instrument for low phase noise mode forces the channels to operate in coupled and reduced noise floor mode. In this case the fine delay feature is disabled.
- The frequency of the external low phase noise clock must be set in the External Sample Frequency box on the clock panel.
- All other features of the instrument function the same as for standard operation.

Performance Specification (Continued)

Phase noise

These plots show the typical phase noise using the delay adjustment

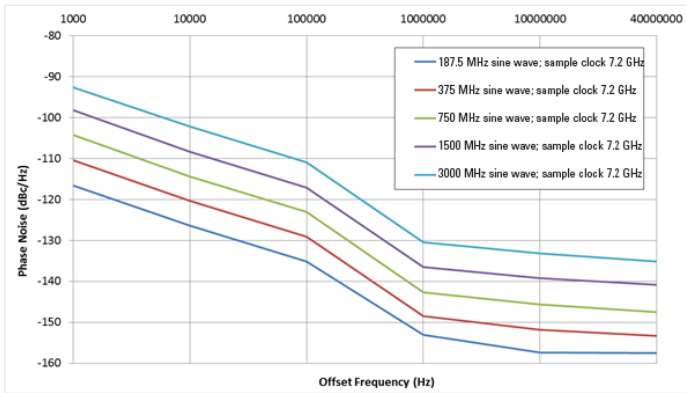

Phase noise plot with internal sample clock, 7.2 GSa/s, direct output measured with balun.

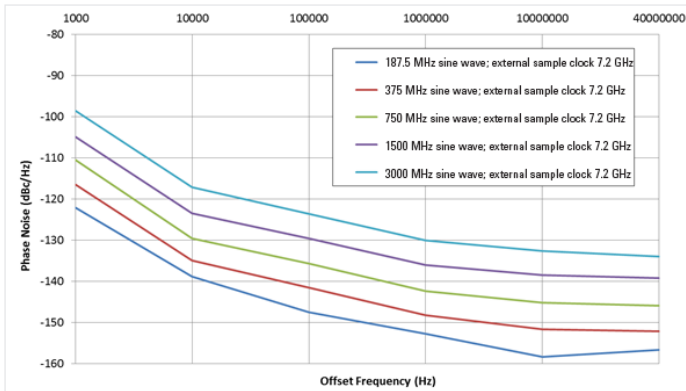

Phase noise plot with external sample clock, 7.2 GSa/s, direct output measured with balun.

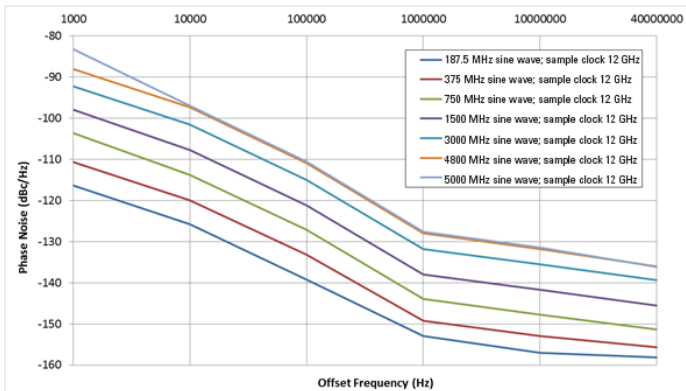

Phase noise plot with internal sample clock, 12 GSa/s, direct output measured with balun.

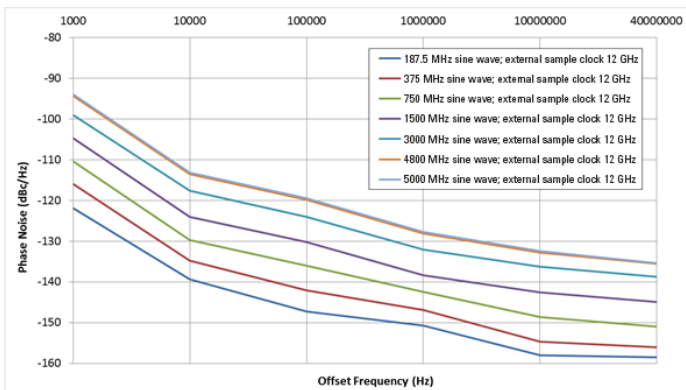

Phase noise plot with external sample clock, 12 GSa/s, direct output measured with balun.

Performance Specification (Continued)

Phase noise (Continued)

These plots show the typical phase noise without using the delay adjustment

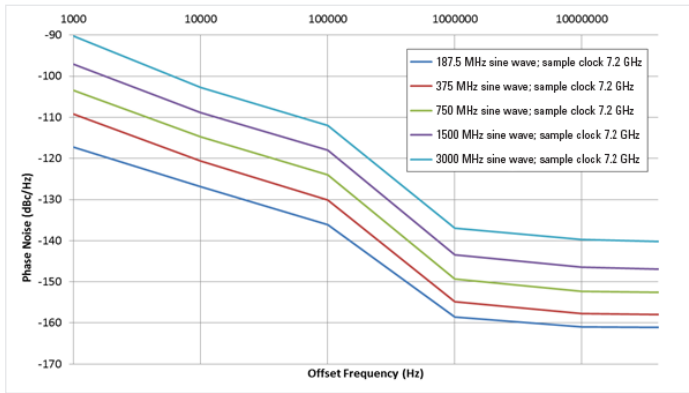

Phase noise with internal sample clock 7.2 GSa/s, direct out measured with balun and reduced noise floor.

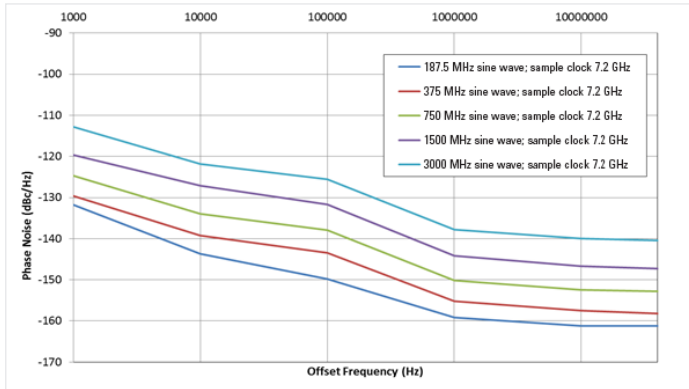

Phase noise with external sample clock 7.2 GSa/s, direct out measured with balun and reduced noise floor.

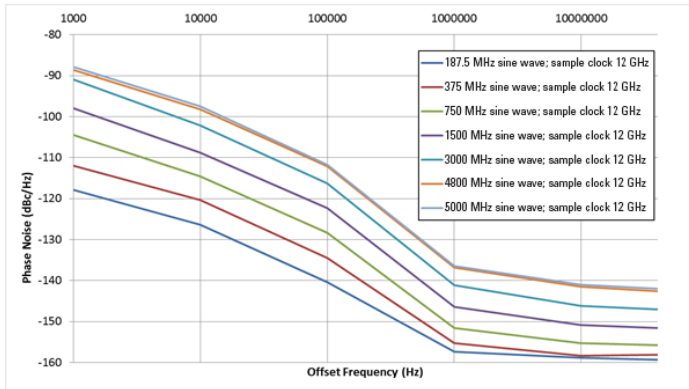

Phase noise with internal sample clock 12 GSa/s, direct out measured with balun and reduced noise floor.

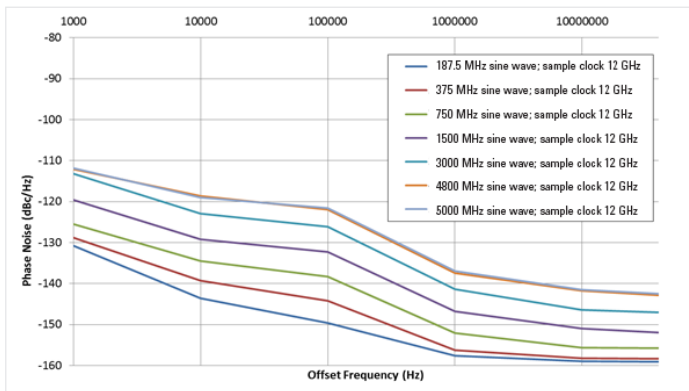

Phase noise with external sample clock 12 GSa/s, direct out measured with balun and reduced noise floor.

Performance Specification (Continued)

Phase noise (Continued)

This plot show the typical phase noise with the low phase noise option (opt. LPN)

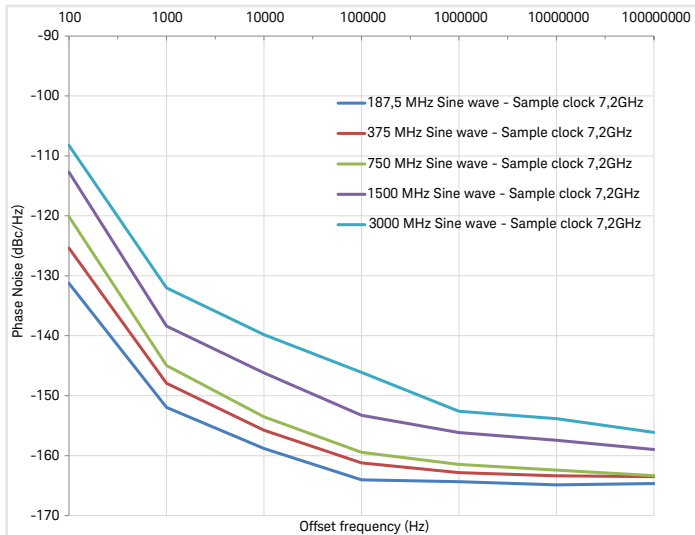

Option LPN significantly improves the arbitrary waveform generator phase noise performance. With option LPN a customer-supplied external synthesizer (1-12 GHz range) must be connected. The measurements in the following graph were performed using a Keysight proprietary external oscillator and measured using a Keysight E5052B signal source analyzer.

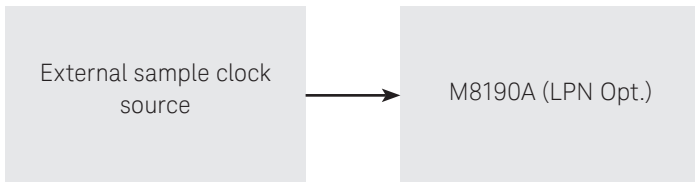

Performance Specification (Continued)

The source for the sample clock output can be either the internal synthesizer or the sample clock input. The source for the sample clock output can be independently selected from the sample clock. For example, it is possible to operate the sample clock output from the internal synthesizer at f_1 to clock the DUT; as an example, f_1 may be divided by two by the DUT. In this case, $f_1/2$ can be connected to the sample clock input as to be used as the sample clock of the M8190A.

Sample clock output	
Source	Selectable, internal synthesizer or sample clock input
Frequency range ¹	1 to 12 GHz
Output amplitude	400 mVpp (nom), fix
Input impedance	50 Ω (nom), AC coupled
Transition time (20 to 80%)	20 ps (typ)
Connector	SMA

1. The sample clock output is derived from the internal sample clock $f_{Sa,i}$. For $f_{Sa,i} = 500 \text{ MSa/s} \dots 1 \text{ GSa/s}$ the sample clock output is twice of $f_{Sa,i}$. For $f_{Sa,i} = 250 \text{ MSa/s} \dots 500 \text{ MSa/s}$ the sample clock output is four times $f_{Sa,i}$. For $f_{Sa,i} = 125 \text{ MSa/s} \dots 250 \text{ MSa/s}$ the sample clock output is eight times $f_{Sa,i}$.

The following table shows which sample clock out routings are possible if coupling is **on**.

Coupling = on			Channel 1			
			External clock		Internal clock	
			12 bit	14 bit	12 bit	14 bit
Channel 2	External clock	12 bit	External clock	–	–	
		14 bit	–	External clock	–	
	Internal clock	12 bit	–	–	Internal clock	
		14 bit	–	–	–	Internal clock

The following table shows which sample clock out routings are possible if coupling is **off**.

Coupling = off			Channel 1			
			External clock		Internal clock	
			12 bit	14 bit	12 bit	14 bit
Channel 2	Channel 2 operate with external clock	12 bit	External or internal clock	External or internal clock	External or internal clock	External or internal clock
		14 bit	External or internal clock	External or internal clock	External or internal clock	External or internal clock
	Channel 2 operate with internal clock	12 bit	External or internal clock	External or internal clock	External or internal clock	–
		14 bit	External or internal clock	External or internal clock	–	External or internal clock

Performance Specification (Continued)

Coupling between channel 1 and channel 2

The two channel instrument (Option 002) has two distinct modes of operation: coupling = off and coupling = on.

Coupling = off

- The two channels operate entirely independently
- The channels may run at different sample clock rates
- The channels may run from the same clock source (internal or external)
- The channels may operate from different clock sources (internal or external)
- The channels are being started asynchronously
- Following parameters can be changed individually per channel:
 - Frequency
 - Amplitude, offset
 - Amplifier path
 - Waveform
 - Sequence
 - Trigger mode (auto, triggered, gated)
 - Start/stop (programming/programming complete)
 - 12 bit or 14 bit mode (see limitations in table below)
 - Dynamic sequencing on/off
- Following parameters can only be changed for both channels:
 - None

The following table shows which mode combinations are available, if coupling is **off**.

Coupling = off			Channel 1			
			External clock		Internal clock	
			12 bit	14 bit	12 bit	14 bit
Channel 2	External clock	12 bit	Available	Available	Available	Available
		14 bit	Available	Available	Available	Available
	Internal clock	12 bit	Available	Available	Available	–
		14 bit	Available	Available	–	Available

Performance Specification (Continued)

Coupling = on

- The two channels start synchronously; the clock source for channel 1 and channel 2 is the same
- The fix delay between channel 1 and channel 2 is the same
- Following parameters can be changed individually per channel:
 - Amplitude, offset
 - Amplifier path
 - Waveform
 - Sequence
 - Trigger mode
 - Variable delay
 - Dynamic sequencing on/off
- Following parameters can only be changed for both channels:
 - Frequency
 - Clock source internal or external
 - Start/stop (programming/programming complete)/abort
 - 12 bit or 14 bit mode
- Notes:
 - When changing from coupling = off to coupling = on, setting of above parameters from channels 1 are being transferred to channel 2
 - Following remote commands that are being sent to channel 1 (or ch2), affect channel 2 (or ch1) as well: frequency, bit mode, start/stop, trigger, event, dynamic segment/sequence select and enable
 - To allow full synchronous operation between channel 1 and channel 2, start/stop, trigger, event, dynamic segment/sequence select and enable always affect both channels; this is valid if the signals are generated at the hardware inputs or by software

The following table shows which mode combinations are available, if coupling is *on*.

Coupling = on			Channel 1			
			External clock		Internal clock	
			12 bit	14 bit	12 bit	14 bit
Channel 2	External clock	12 bit	Available	–	–	–
		14 bit	–	Available	–	–
	Internal clock	12 bit	–	–	Available	–
		14 bit	–	–	–	Available

Performance Specification (Continued)

Internal trigger generator	
Frequency range	100 mHz to f_{\max}
f_{\max}	Sync clock out frequency divided by 5 – e.g.: 12 bit mode, $f_{\text{Sa}} = 12 \text{ GHz}$: $f_{\max} = 12 \text{ GHz}/64/5 = 37.5 \text{ MHz}$ – e.g.: 14 bit mode, $f_{\text{Sa}} = 8 \text{ GHz}$: $f_{\max} = 8 \text{ GHz}/48/5 = 33.3 \text{ MHz}$
Frequency resolution	100 mHz

Sequencer

The standard configuration of the M8190A offers:

- Continuous, self armed mode with one segment
- Triggered, self armed with one segment
- Gated, self armed with one segment

Sample memory	
– Standard	128 MSa per channel
– Option 02G 12 bit mode	2048 MSa per channel
– Option 02G 14 bit mode	1536 MSa per channel
Option SEQ offers the enhanced sequencing functionality described below	
Minimum segment length	320 samples in 12 bit mode; 240 samples in 14 bit mode
Waveform granularity	64 samples in 12 bit mode; 48 samples in 14 bit mode
Segments	1 to 512 k (2^{19}) unique segments The maximum length of a segment can be up to 2048 MSa. A single segment can consist of multiple sections that are downloaded individually to the instrument and are linked inside the M8190A to form a segment.
Segment loops	A total of 4 billion (2^{32}) loops can be defined for each segment
Sequences	Up to 512 k (2^{19}) total unique waveform sequences can be defined. A sequence is a continuous series of segments.
Sequence table entries	Up to 512 k segment table entries can be defined as the sum of entries for all sequence tables
Sequence loops	A total of 4 billion (2^{32}) loops can be defined for each sequence
Scenarios	Up to 512 k (2^{19}) scenarios can be defined. A scenario is a continuous series of sequences Up to 512 k (2^{19}) loop can be defined for each scenario
Scenario table entries	Each sequence in a scenario can be looped up to 4 billion (2^{32}) times. Switching between different scenarios is controlled by software.
Dynamic scenario control	A parallel input bus is used to externally switch between scenarios. Jumps between scenarios can be immediate (current scenario is interrupted) or synchronous (current scenario is completed before jumping to the next scenario).

Digital Up-Conversion

In a two-channel instrument, each channel has a separate digital up-conversion engine. All parameters (e.g. carrier frequency, amplitude, waveforms, etc.) can be set independently. If the two channels are used in “coupled” mode, they are fully phase coherent.

Characteristics	Description
Sampling rate	1000 MSa/s to 7200 MSa/s
Carrier frequency	
Range	0 Hz ... 12 GHz (observe frequency response and sin x/x roll-off)
– Resolution	Sample clock/2 ⁷²
– Phase range	0 – 360°
– Phase resolution	0.002°
– Amplitude range	0 to 100%
– Amplitude resolution	20,000 steps
– Frequency sweep rate	2 Hz/hour to 40 GHz/μs
Sample memory	
– Depth	768 M IQ sample pairs
– Granularity	24
– Minimum segment length for data segments	120 IQ pairs
– Minimum segment length for configuration segments	240 IQ Pairs
Vertical resolution IQ	15 bit samples for I and Q
Vertical resolution DAC	14 bit independent of 12 bit mode and 14 bit mode
Interpolation factors	x3, x12, x24, x48
SFDR and harmonics	See specs in 14 bit mode
Mode dependent modulation bandwidth Interpolation factor	Max. input sample rate Max. modulation bandwidth
– x3	2400 MSa/s 1920 MHz
– x12	600 MSa/s 480 MHz
– x24	300 MSa/s 240 MHz
– x48	150 MSa/s 120 MHz
Modulation bw ripple	0.8 x Fs, where Fs is the input I/Q sample rate, max 1 dB
– Delay (fSa = 1 GSa/s to 7.2 GSa/s)	
– Trigger/event in to direct out	Interpolation factor * 3840 sample clock cycles + 4.5 sample clock cycles – 5.3 ns (nom)
– Trigger/event in to DC out	Interpolation factor * 3840 sample clock cycles + 4.5 sample clock cycles – 4.6 ns (nom)
– Trigger/event in to AC out	Interpolation factor * 3840 sample clock cycles + 4.5 sample clock cycles – 4.5 ns (nom)
– Delay sync marker out to direct out	4.5 sample clock cycles – 8.0 ns (nom)
– Delay sample marker out to direct out	-1.3 ns + 4.5 sample clock cycles (typ)
Sync clock output	Sample clock divided by (24 x interpolation factor)
Minimum latency	Interpolation factor * 10320 sample clock cycles (meas)
Trigger/gate and event input	
– Maximum toggle frequency	Sample clock output frequency divided by (120 * interpolation factor)

Digital Up-Conversion (Continued)

Marker		
Sync marker		
- Timing resolution	24 input IQ sample pairs	
- Width	Multiples of 24 input IQ sample pairs	
Sample marker		
- Timing resolution	1 input IQ sample pair	
- Width	Interpolation factor	Width in DAC output samples
	x3	24
	x12	24
	x24	24
	x48	48
Sample marker output delay	Marker to data is 3.5 sample clock cycles	

Memory management

The IQ baseband waveform and waveform attributes such as carrier frequency, phase, and amplitude are stored independently. Thus, repetitive waveforms with different attributes can be stored much more efficiently. Attributes are stored in tables. The sequencer connects waveform and its attributes at runtime. Carrier frequency and amplitude can also be controlled by software.

Table sizes

- Amplitude table	32 k
- Frequency table	32 k
- Action table	32 k

Actions include: Set carrier frequency, set amplitude, set phase, reset phase, phase bump, set sweep rate, sweep run, sweep stop

General

Power consumption	210 W (nom, 12 GSa/s operation)
Operating temperature	0 °C to 40 °C
Operating humidity	5% to 80% relative humidity, non-condensing
Operating altitude	Up to 2000 m
Storage temperature	-40 °C to 70 °C
Stored states	User configurations and factory default
Power on state	Default
Interface to controlling PC	PCIe (see AXIe chassis specification)
Form factor	2-slot AXIe
Dimensions (WxHxD)	60 mm x 322.5 mm x 281.5 mm
Weight	4.9 kg
Safety designed to	IEC61010-1, UL61010, CSA22.2 61010.1 certified
EMC tested to	IEC61326
Warm-up time	30 min
Calibration interval	2 years recommended
Warranty	3 years standard

Cooling requirements

When operating the M8190A choose a location that provides at least 80 mm of clearance at rear, and at least 30 mm of clearance at each side.

Download times

Download times: Using IVI-COM driver

- 1 M samples	3 ms (meas)
- 128 M samples	350 ms (meas)
- 512 M samples	1.4 s (meas)
- 2 G samples	6 s (meas)

Definitions

Specification (spec)	The warranted performance of a calibrated instrument that has been stored for a minimum of 2 hours within the operating temperature range of 0 °C to – 40 °C and after a 45-minute warm up period. Within ± 10 °C after autocal. All specifications include measurement uncertainty and were created in compliance with ISO-17025 methods. Data published in this document are specifications (spec) only where specifically indicated.
Typical (typ)	The characteristic performance, which 80% or more of manufactured instruments will meet. This data is not warranted, does not include measurement uncertainty, and is valid only at room temperature (approximately 23 °C).
Nominal (nom)	The mean or average characteristic performance, or the value of an attribute that is determined by design such as a connector type, physical dimension, or operating speed. This data is not warranted and is measured at room temperature (approximately 23 °C).
Measured (meas)	An attribute measured during development for purposes of communicating the expected performance. This data is not warranted and is measured at room temperature (approximately 23 °C).
Accuracy	Represents the traceable accuracy of a specified parameter. Includes measurement error and timebase error, and calibration source uncertainty.

Software

Operating systems	Supported operating system is Windows 7 (32 or 64 bit), Windows 8 (32 or 64 bit), Windows 8.1 (32 or 64 bit) Windows 10 (32 or 64 bit)
Soft front panel	A graphical user interface (GUI or soft front panel) is offered to control all functionality for the instrument. It contains screens for controlling clock, outputs, marker, trigger, sequencer, importing waveforms and creating standard waveforms.
SCPI language	Remote control via SCPI
IVI-driver	An IVI-COM driver as well as IVI-C driver are available as part of the M8190A software

PCI-SIG®, PCIe® and the PCI Express® are US registered trademarks and/or service marks of PCI-SIG.

Learn more at: www.keysight.com

For more information on Keysight Technologies' products, applications or services, please contact your local Keysight office. The complete list is available at: www.keysight.com/find/contactus

