

# E4981A Capacitance Meter



## Table of Contents

Definitions and Specifications .....	3
Measurement display ranges .....	5
Available measurement ranges.....	5
Available measurement ranges.....	6
Available measurement ranges.....	6
Accuracy when ambient temperature exceeds the range of 18 to 28 °C (typical) .....	8
Accuracy when an Alternative Current magnetic field is applied .....	8
Measurement accuracy .....	9
Supplemental Information .....	16
Measurement signals .....	16
Measurement time .....	16
Display time .....	17
Measurement data transfer time .....	18
Measurement Assistance Functions .....	19
General Specifications .....	22
EMC, Safety, Environment and Compliance.....	25
EMC, Safety, Environment and Compliance.....	26
Sample Calculation of Measurement Accuracy .....	27
Sample .....	27
When measurement parameter is Cp-D (or Cs-D) .....	27
When measurement parameter is Cp-Q (or Cs-Q).....	27
When measurement parameter is Cp-G .....	28
When measurement parameter is Cp-Rp .....	28
When measurement parameter is Cs-Rs.....	28

## Definitions and Specifications

This document provides specifications and supplemental information for the Keysight Technologies, Inc. E4981A capacitance meter. All specifications apply to the conditions of a 0 °C to 45 °C temperature range, unless otherwise stated, and 30 minutes after the instrument has been turned on.

Table 1.

Definitions	
Specification (spec.)	<p>Warranted performance. Specifications include guard bands to account for the expected statistical performance distribution, measurement uncertainties, and changes in performance due to environmental conditions.</p> <p>Supplemental information is intended to provide information that is helpful for using the instrument but that is not guaranteed by the product warranty.</p>
Typical (typ.)	Describes performance that will be met by a minimum of 80% of all products. It is not guaranteed by the product warranty.
Nominal (nom.)	A general descriptive term that does not imply a level of performance.

Table 2.

Option dependencies	<p>The available frequency is defined as follows.</p> <p>E4981A-001: 120 Hz/1 kHz/1 MHz/1 MHz ± 1%/1 MHz ± 2% E4981A-002: 120 Hz/1 kHz</p> <p>The information regarding “Frequency 1 MHz/1 MHz ± 1%/1 MHz ± 2%” in specifications, supplemental and general information is not valid for the E4981A-002.</p>
---------------------	--

Table 3.

Basic specifications	
Measurement parameters	<ul style="list-style-type: none"> <li>• Cp-D, Cp-Q, Cp-Rp, Cp-G</li> <li>• Cs-D, Cs-Q, Cs-Rs</li> </ul> <p>where</p> <p>Cp: Capacitance value measured using the parallel equivalent circuit model            Cs: Capacitance value measured using the series equivalent circuit model            D: Dissipation factor            Q: Quality factor (inverse of D)            G: Equivalent parallel conductance measured using the parallel equivalent circuit model            Rp: Equivalent parallel resistance measured using the parallel equivalent circuit model            Rs: Equivalent series resistance measured using the series equivalent circuit model</p>

Table 4.

Specifications				
Measurement signals				
Frequency	Allowable frequencies	120 Hz 1 kHz 1 MHz 0.98 MHz (1 MHz – 2%) 0.99 MHz (1 MHz – 1%) 1.01 MHz (1 MHz + 1%) 1.02 MHz (1 MHz + 2%)		
	Accuracy	±0.02%		
Level	Range	0.1 V to 1 V		
	Resolution	0.01 V		
	Accuracy	±5%		
Output mode	Continuous or Synchronous			
Source delay time <sup>1</sup>	Range	0 to 1 s		
	Resolution	0.1 ms		
Measurement cable lengths	0 m, 1 m, 2 m			
Measurement time selection	5 speeds measurement time mode N = 1, 2, 4, 6, 8. For information on the measurement time in each mode, refer to Table 22 “Measurement time.”			
Measurement range selection	Auto, Hold			
Measurement range				
Measurement signal frequency: 120 Hz	10 nF	22 nF	47 nF	100 nF
	220 nF	470 nF	1 µF	2.2 µF
	4.7 µF	10 µF	22 µF	47 µF
	100 µF	220 µF	470 µF	1 mF
Measurement signal frequency: 1 kHz	100 pF	220 pF	470 pF	1 nF
	2.2 nF	4.7 nF	10 nF	22 nF
	47 nF	100 nF	220 nF	470 nF
	1 µF	2.2 µF	4.7 µF	10 µF
Measurement signal frequency: 1 MHz / 1 MHz ± 1% / 1 MHz ± 2%	22 µF	47 µF	100 µF	
	1 pF	2.2 pF	4.7 pF	10 pF
	22 pF	47 pF	100 pF	220 pF
	470 pF	1 nF		
For information on measurable range in each measurement mode, refer to “Available measurement ranges” (Tables 7 through 9).				
1. Source delay time is effective when output mode is set to Synchronous mode.				

Table 5.

Averaging	
Range	1 to 256 measurements
Resolution	1
Trigger mode:	
Internal trigger (Int), Manual trigger (Man), External trigger (Ext), GPIB/USB/LAN trigger (Bus)	
Trigger delay time	
Range	0 to 1 s
Resolution	0.1 ms

## Measurement display ranges

Table 6 shows the range of the measured value that can be displayed on the screen.

Table 6. Allowable measured value display range

Parameter	Measurement display range
Cs, Cp	±1.000000 aF to 999.9999 EΩ
D	±0.000001 to 9.999999
Q	±0.01 to 99999.99
Rs, Rp	±1.000000 aΩ to 999.9999 EΩ
G	±1.000000 aS to 999.9999 ES
Δ%	±0.0001 % to 999.9999 %
a: 1 x 10 <sup>-18</sup> , E: 1 x 10 <sup>18</sup>	

## Available measurement ranges

Tables 7 through 9 show recommended measurement ranges (recommended for accurate measurement) and significant measurement ranges (ranges that do not cause overload) for each measurement value under the condition D (dissipation factor) ≤ 0.5.

Table 7. Measurable capacitance ranges when measurement frequency is 120 Hz

Measurement range setting	Recommended measurement range	Significant measurement range
10 nF	0 F to 15 nF	0 F to 15 nF
22 nF	15 nF to 33 nF	0 F to 33 nF
47 nF	33 nF to 68 nF	0 F to 68 nF
100 nF	68 nF to 150 nF	0 F to 150 nF
220 nF	150 nF to 330 nF	0 F to 330 nF
470 nF	330 nF to 680 nF	0 F to 680 nF
1 μF	680 nF to 1.5 μF	0 F to 1.5 μF
2.2 μF	1.5 μF to 3.3 μF	0 F to 3.3 μF
4.7 μF	3.3 μF to 6.8 μF	0 F to 6.8 μF
10 μF	6.8 μF to 15 μF	0 F to 15 μF
22 μF	15 μF to 33 μF	0 F to 33 μF
47 μF	33 μF to 68 μF	0 F to 68 μF
100 μF	68 μF to 150 μF	0 F to 150 μF
220 μF	150 μF to 330 μF	0 F to 330 μF
470 μF	330 μF to 680 μF	0 F to 680 μF
1 mF	680 μF to 2 mF	0 F to 2 mF

## Available measurement ranges

Table 8. Measurable capacitance ranges when measurement frequency is 1 kHz

Measurement range setting	Recommended measurement range	Significant measurement range
100 pF	0 pF to 150 pF	0 F to 150 pF
220 pF	150 pF to 330 pF	0 F to 330 pF
470 pF	330 pF to 680 pF	0 F to 680 pF
1 nF	680 pF to 1.5 nF	0 F to 1.5 nF
2.2 nF	1.5 nF to 3.3 nF	0 F to 3.3 nF
4.7 nF	3.3 nF to 6.8 nF	0 F to 6.8 nF
10 nF	6.8 nF to 15 nF	0 F to 15 nF
22 nF	15 nF to 33 nF	0 F to 33 nF
47 nF	33 nF to 68 nF	0 F to 68 nF
100 nF	68 nF to 150 nF	0 F to 150 nF
220 nF	150 nF to 330 nF	0 F to 330 nF
470 nF	330 nF to 680 nF	0 F to 680 nF
1 $\mu$ F	680 nF to 1.5 $\mu$ F	0 F to 1.5 $\mu$ F
2.2 $\mu$ F	1.5 $\mu$ F to 3.3 $\mu$ F	0 F to 3.3 $\mu$ F
4.7 $\mu$ F	3.3 $\mu$ F to 6.8 $\mu$ F	0 F to 6.8 $\mu$ F
10 $\mu$ F	6.8 $\mu$ F to 15 $\mu$ F	0 F to 15 $\mu$ F
22 $\mu$ F	15 $\mu$ F to 33 $\mu$ F	0 F to 33 $\mu$ F
47 $\mu$ F	33 $\mu$ F to 68 $\mu$ F	0 F to 68 $\mu$ F
100 $\mu$ F	68 $\mu$ F to 200 $\mu$ F	0 F to 200 $\mu$ F

## Available measurement ranges

Table 9. Measurable capacitance ranges when measurement frequency is 1 MHz, 1 MHz  $\pm$ 1%, 1 MHz  $\pm$ 2%

Measurement range setting	Recommended measurement range	Significant measurement range
1 pF	0 F to 1.5 pF	0 F to 1.5 pF
2.2 pF	1.5 pF to 3.3 pF	0 F to 3.3 pF
4.7 pF	3.3 pF to 6.8 pF	0 F to 6.8 pF
10 pF	6.8 pF to 15 pF	0 F to 15 pF
22 pF	15 pF to 33 pF	0 F to 33 pF
47 pF	33 pF to 68 pF	0 F to 68 pF
100 pF	68 pF to 150 pF	0 F to 150 pF
220 pF	150 pF to 330 pF	0 F to 330 pF
470 pF	330 pF to 680 pF	0 F to 680 pF
1 nF	680 pF to 1.5 nF	0 F to 1.5 nF

Table 10. Measurement accuracy

Measurement accuracy	<p>The measurement accuracy is defined when all of the following conditions are met:</p> <ul style="list-style-type: none"> <li>• Warm-up time: 30 minutes or longer</li> <li>• Ambient temperature: 18 °C to 28 °C</li> <li>• Execution of OPEN Correction</li> <li>• Execution of Cable Correction for 1 MHz measurement</li> <li>• Measurement cable length: 0 m, 1 m, or 2 m (16048A/B/D)1</li> <li>• D (dissipation factor) ≤ 0.5</li> </ul>
Basic accuracy (typical)	C: 0.042%, D: 0.0003
Accuracy of Cp, Cs, D, G, Rs, Q and Rp	<ul style="list-style-type: none"> <li>• Tables 14 through 19 show the measurement accuracy of Cp, Cs, and D when D ≤ 0.1.</li> <li>• Table 21 shows the formula of the measurement accuracy of G, Rs, Q and Rn when D ≤ 0.1.</li> <li>• When 0.1 &lt; D ≤ 0.5, multiply the accuracy obtained in Tables 14 through 21 by the coefficient in Table 11.</li> </ul>

Table 11. Dissipation factor Coefficient

Parameter	Coefficient
Cp, Cs, G, Rs <sup>2</sup>	1 + D <sup>2</sup>
D	1 + D

Table 12. Formula of the measurement accuracy of G, Rs, Q and Rp

Parameter	Formula
G <sub>e</sub> (G accuracy)	$(C_e/100) \times 2 \times \pi \times f \times C_x$
Rs <sub>e</sub> (Rs accuracy)	$(C_e/100) / (2 \times \pi \times f \times C_x)$
Q <sub>e</sub> (Q accuracy)	$\frac{\pm Q_x^2 \times D_e}{1 \mp Q_x \times D_e}$
Rp <sub>e</sub> (Rp accuracy)	$\frac{\pm R_{px}^2 \times G_e}{1 \mp R_{px} \times G_e}$

C<sub>e</sub>: Cp or Cs accuracy [%]

f: Measurement frequency [Hz]

C<sub>x</sub>: Measurement value of Cp or Cs [F]

Q<sub>x</sub>: Measurement value of Q

Rp<sub>x</sub>: Measurement value of Rp [Ω]

D<sub>e</sub>: D accuracy [%]

1. The outer conductor resistance of cable requires the following condition.

16048A/B: 62 mΩ or below

16048D: 90 mΩ or below

2. If you select a secondary measurement parameter other than D, calculate D.

## Accuracy when ambient temperature exceeds the range of 18 to 28 °C (typical)

When the ambient temperature exceeds the range of 18 to 28 °C, multiply the accuracy obtained above by the coefficient shown in the table below.

Table 13 (7). Temperature Coefficient

	Coefficient
0 °C ≤ ambient temperature < 8 °C	3
8 °C ≤ ambient temperature < 18 °C	2
18 °C ≤ ambient temperature ≤ 28 °C	1
28 °C ≤ ambient temperature ≤ 38 °C	2
38 °C ≤ ambient temperature ≤ 45 °C	3

## Accuracy when an Alternative Current magnetic field is applied

When an alternating current magnetic field is applied to the instrument. Multiply the accuracy obtained in Tables 14 through 19.

$$1 + B \times (2 + 0.5 \times K)$$

B: Magnetic flux density [Gauss]

Cx: Measured value of the capacitance (Cp or Cs), Cr: A measurement range [F]

Vs: A measurement signal level [V].

In Tables 14 through 19, K is defined as follows:

$$Cx \leq Cr: K = (1/Vs) \times (Cr/Cx)$$

$$Cx > Cr: K = 1/Vs$$

where

Cx is measured value of the capacitance (Cp or Cs),

Cr is a measurement range and

Vs is a measurement signal level [V].



## Measurement accuracy

Table 14. Measurement accuracy of Cp, Cs (measurement frequency: 120 Hz)

Cp, Cs [%]

Measurement time mode (N)	1	2	4	6	8
10 nF, 22 nF, 47 nF, 100 nF, 220 nF, 470 nF, 1 µF, 2.2 µF, 4.7 µF, 10 µF, 22 µF, 47 µF, 100 µF	$0.055 + 0.030 \times K$	$0.055 + 0.022 \times K$	$0.055 + 0.018 \times K$	$0.055 + 0.016 \times K$	$0.055 + 0.015 \times K$
220 µF, 470 µF, 1 mF	$0.4 + 0.060 \times K$	$0.4 + 0.044 \times K$	$0.4 + 0.036 \times K$	$0.4 + 0.032 \times K$	$0.4 + 0.030 \times K$

Table 15. Measurement accuracy of D (measurement frequency: 120 Hz)

D

Measurement time mode (N)	1	2	4	6	8
10 nF, 22 nF, 47 nF, 100 nF, 220 nF, 470 nF, 1 µF, 2.2 µF, 4.7 µF, 10 µF, 22 µF, 47 µF, 100 µF	$0.00035 + 0.00030 \times K$	$0.00035 + 0.00022 \times K$	$0.00035 + 0.00018 \times K$	$0.00035 + 0.00016 \times K$	$0.00035 + 0.00015 \times K$
220 µF, 470 µF, 1 mF	$0.004 + 0.00060 \times K$	$0.004 + 0.00044 \times K$	$0.004 + 0.00036 \times K$	$0.004 + 0.00032 \times K$	$0.004 + 0.00030 \times K$

Table 16. Measurement accuracy of Cp, Cs (measurement frequency: 1 kHz)

Cp, Cs [%]

Measurement time mode (N)	1	2	4	6	8
100 pF	$0.055 + 0.070 \times K$	$0.055 + 0.047 \times K$	$0.055 + 0.036 \times K$	$0.055 + 0.033 \times K$	$0.055 + 0.030 \times K$
220 pF	$0.055 + 0.045 \times K$	$0.055 + 0.032 \times K$	$0.055 + 0.025 \times K$	$0.055 + 0.022 \times K$	$0.055 + 0.020 \times K$
470 pF, 1 nF, 2.2 nF, 4.7 nF, 10 nF, 22 nF, 47 nF, 100 nF, 220 nF, 470 nF, 1 µF, 2.2 µF, 4.7 µF, 10 µF	$0.055 + 0.030 \times K$	$0.055 + 0.022 \times K$	$0.055 + 0.018 \times K$	$0.055 + 0.016 \times K$	$0.055 + 0.015 \times K$
22 µF, 47 µF, 100 µF	$0.4 + 0.060 \times K$	$0.4 + 0.044 \times K$	$0.4 + 0.036 \times K$	$0.4 + 0.032 \times K$	$0.4 + 0.030 \times K$

Table 17. Measurement accuracy of D (measurement frequency: 1 kHz)

D

Measurement time mode (N)	1	2	4	6	8
100 pF	$0.00035 + 0.00070 \times K$	$0.00035 + 0.00047 \times K$	$0.00035 + 0.00036 \times K$	$0.00035 + 0.00033 \times K$	$0.00035 + 0.00030 \times K$
220 pF	$0.00035 + 0.00045 \times K$	$0.00035 + 0.00032 \times K$	$0.00035 + 0.00025 \times K$	$0.00035 + 0.00022 \times K$	$0.00035 + 0.00020 \times K$
470 pF, 1 nF, 2.2 nF, 4.7 nF, 10 nF, 22 nF, 47 nF, 100 nF, 220 nF, 470 nF, 1 μF, 2.2 μF, 4.7 μF, 10 μF	$0.00035 + 0.00030 \times K$	$0.00035 + 0.00022 \times K$	$0.00035 + 0.00018 \times K$	$0.00035 + 0.00016 \times K$	$0.00035 + 0.00015 \times K$
22 μF, 47 μF, 100 μF	$0.004 + 0.00060 \times K$	$0.004 + 0.00044 \times K$	$0.004 + 0.00036 \times K$	$0.004 + 0.00032 \times K$	$0.004 + 0.00030 \times K$

Table 18. Measurement accuracy of Cp, Cs (measurement frequency: 1 MHz, 1 MHz ± 1%, 1 MHz ± 2%)

Cp, Cs [%]

Measurement time mode (N)	1	2	4	6	8
1 pF	$0.055 + 0.070 \times K$	$0.055 + 0.047 \times K$	$0.055 + 0.036 \times K$	$0.055 + 0.033 \times K$	$0.055 + 0.030 \times K$
2.2 pF	$0.055 + 0.045 \times K$	$0.055 + 0.032 \times K$	$0.055 + 0.025 \times K$	$0.055 + 0.022 \times K$	$0.055 + 0.020 \times K$
4.7 pF, 10 pF, 22 pF, 47 pF, 100 pF, 220 pF, 470 pF, 1 nF	$0.055 + 0.030 \times K$	$0.055 + 0.022 \times K$	$0.055 + 0.018 \times K$	$0.055 + 0.016 \times K$	$0.055 + 0.015 \times K$

Table 19. Measurement accuracy of D (measurement frequency: 1 MHz, 1 MHz ± 1%, 1 MHz ± 2%)

D

Measurement time mode (N)	1	2	4	6	8
1 pF	$0.00035 + 0.00070 \times K$	$0.00035 + 0.00047 \times K$	$0.00035 + 0.00036 \times K$	$0.00035 + 0.00033 \times K$	$0.00035 + 0.00030 \times K$
2.2 pF	$0.00035 + 0.00045 \times K$	$0.00035 + 0.00032 \times K$	$0.00035 + 0.00025 \times K$	$0.00035 + 0.00022 \times K$	$0.00035 + 0.00020 \times K$
4.7 pF, 10 pF, 22 pF, 47 pF, 100 pF, 220 pF, 470 pF, 1 nF	$0.00035 + 0.00030 \times K$	$0.00035 + 0.00022 \times K$	$0.00035 + 0.00018 \times K$	$0.00035 + 0.00016 \times K$	$0.00035 + 0.00015 \times K$

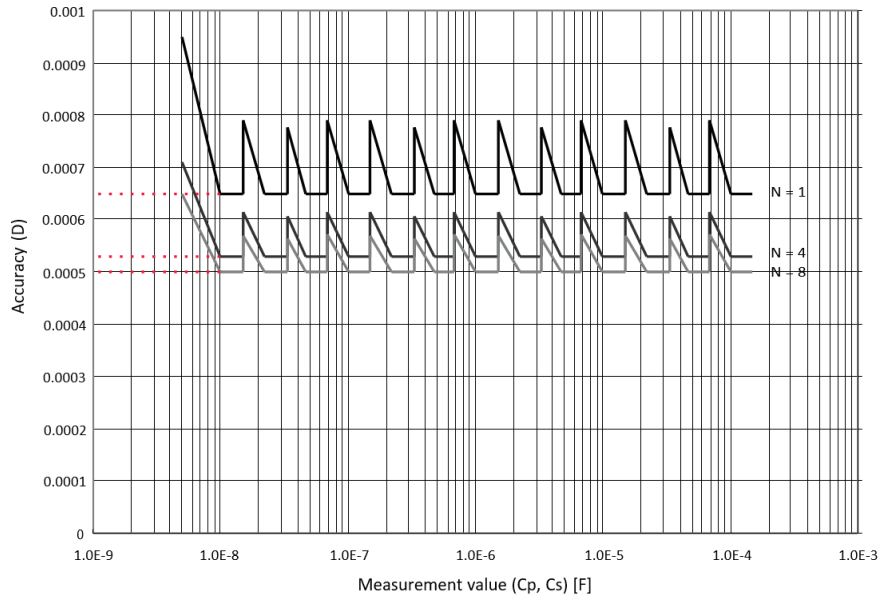

Figure 1. Accuracy of D when measurement frequency is 120 Hz  
 (measurement range: 10 nF to 100  $\mu$ F / measurement signal level: 0.5 V)

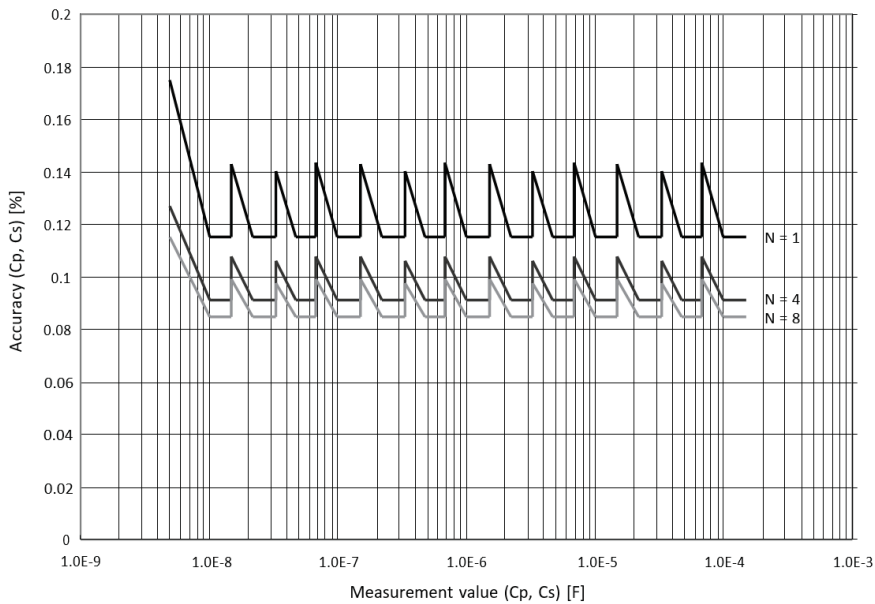

Figure 2. Accuracy of Cp and Cs when measurement frequency is 120 Hz  
 (measurement range: 10 nF to 100  $\mu$ F / measurement signal level: 0.5 V)

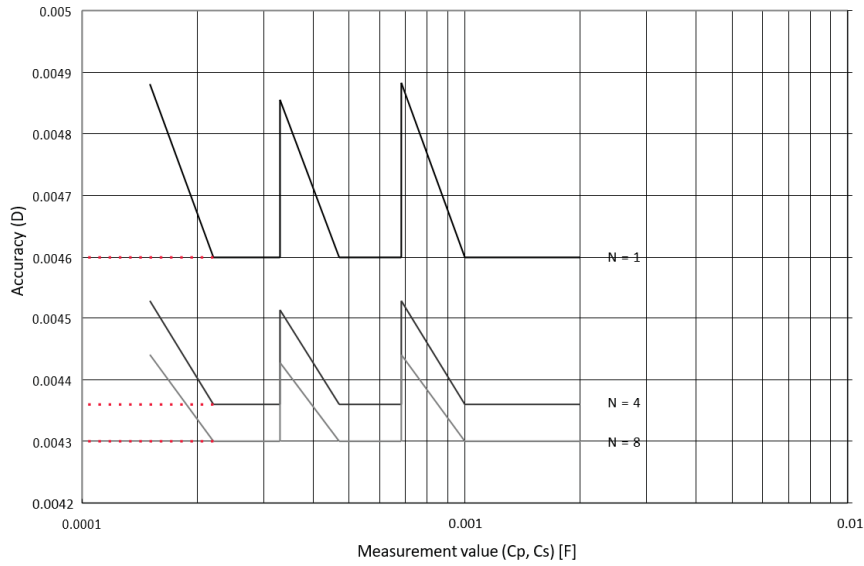

Figure 3. Accuracy of D when measurement frequency is 120 Hz  
(measurement range: 220  $\mu$ F to 1 mF / measurement signal level: 1 V)

Accuracy of Cp and Cs when measurement frequency is 120 Hz (measurement signal level: 0.5 V)

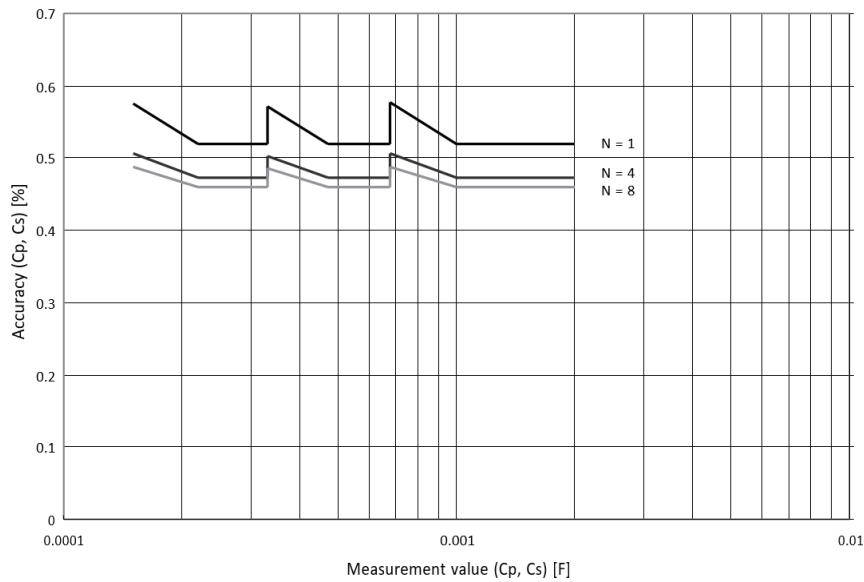

Figure 4. Accuracy of Cp and Cs when measurement frequency is 120 Hz  
(measurement range: 220  $\mu$ F to 1 mF / measurement signal level: 1 V)

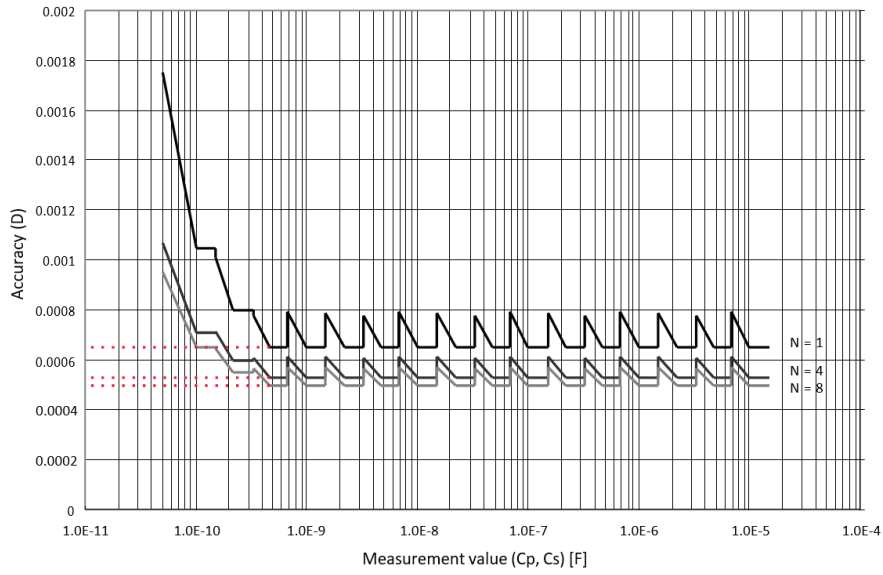

Figure 5. Accuracy of D when measurement frequency is 1 kHz  
(measurement range: 100 pF to 10  $\mu$ F / measurement signal level: 1 V)

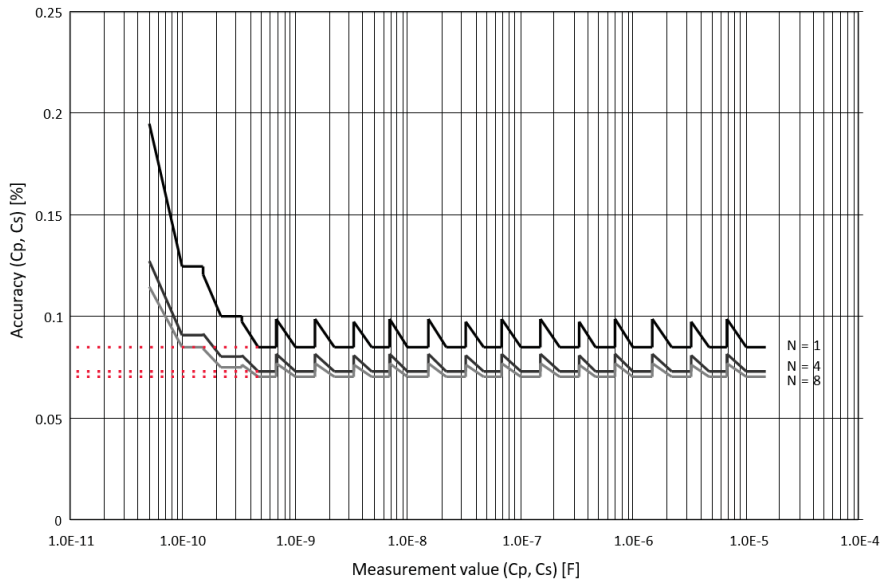

Figure 6. Accuracy of Cp and Cs when measurement frequency is 1 kHz  
(measurement range: 100 pF to 10  $\mu$ F / measurement signal level: 1 V)

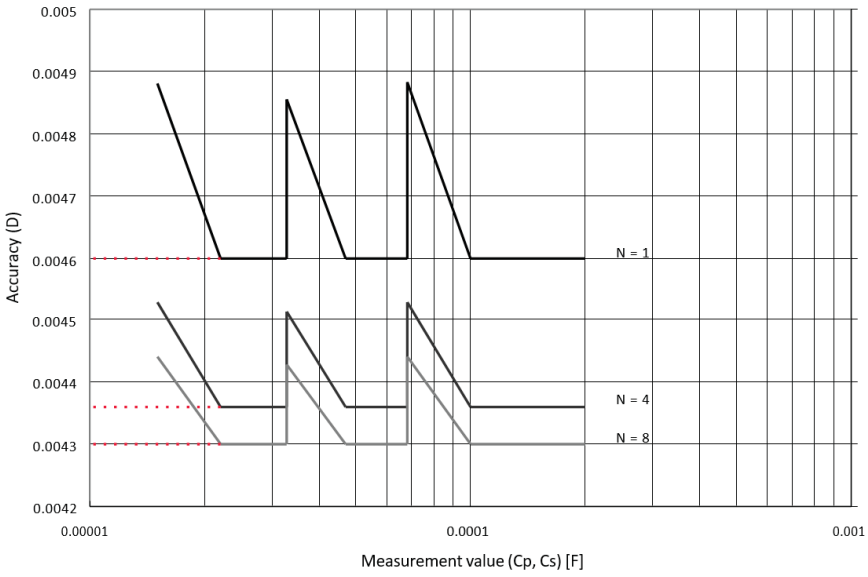

Figure 7. Accuracy of D when measurement frequency is 1 kHz  
(measurement range: 22  $\mu$ F to 100  $\mu$ F / measurement signal level: 1 V)

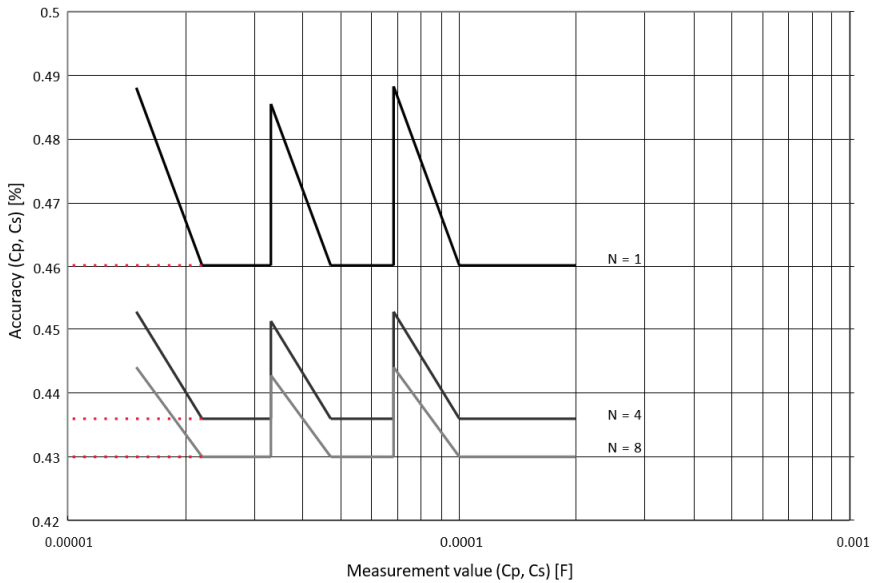

Figure 8. Accuracy of Cp and Cs when measurement frequency is 1 kHz  
(measurement range: 22  $\mu$ F to 100  $\mu$ F / measurement signal level: 1 V)

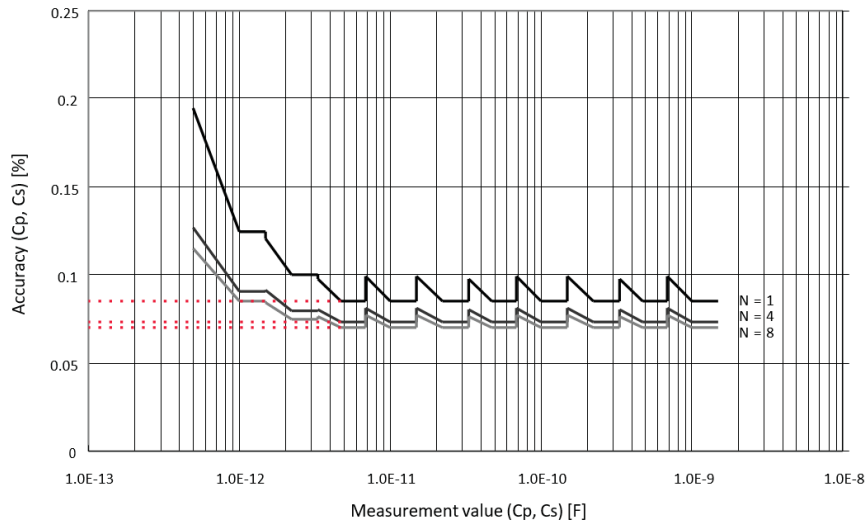

Figure 9. Accuracy of Cp and Cs when measurement frequency is 1 MHz (measurement signal level: 1 V)

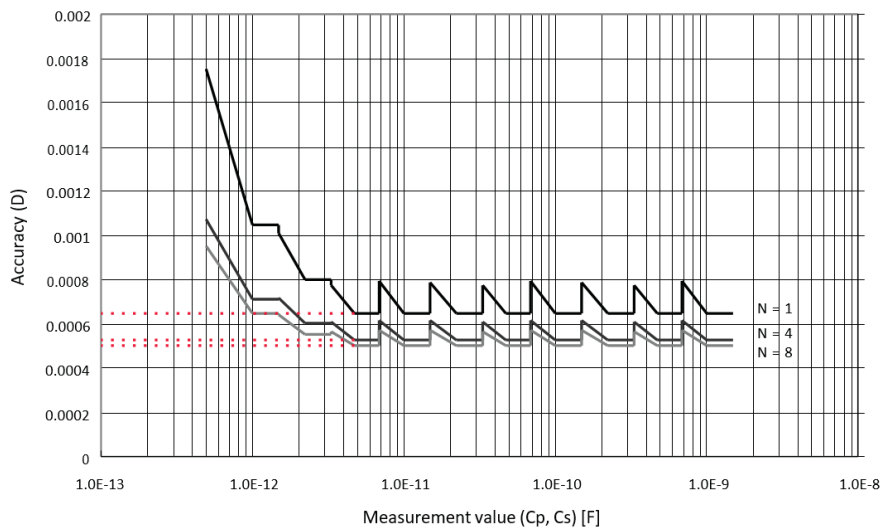

Figure 10. Accuracy of D when measurement frequency is 1 MHz (measurement signal level: 1 V)

Sample calculation of measurement accuracy is described at the end of the document.

## Supplemental Information

### Measurement signals

Table 20.

Output impedance	Frequency: 120 Hz	SLC OFF ( $\geq 220 \mu\text{F}$ range) SLC ON ( $\geq 220 \mu\text{F}$ range) 2.2 $\mu\text{F}$ to 100 $\mu\text{F}$ range 10 nF to 1 $\mu\text{F}$ range	1.5 $\Omega$ (nom.) <sup>1</sup> 0.3 $\Omega$ (nom.) <sup>1</sup> 0.3 $\Omega$ (nom.) <sup>1</sup> 20 $\Omega$ (nom.) <sup>1</sup>
	Frequency: 1 kHz	SLC OFF ( $\geq 22 \mu\text{F}$ range) SLC ON ( $\geq 22 \mu\text{F}$ range) 220 nF to 10 $\mu\text{F}$ range 100 pF to 100 nF range	1.5 $\Omega$ (nom.) <sup>1</sup> 0.5 $\Omega$ (nom.) <sup>1</sup> 0.3 $\Omega$ (nom.) <sup>1</sup> 20 $\Omega$ (nom.) <sup>1</sup>
	Frequency: 1 MHz / 1 MHz $\pm$ 2% / 1 MHz $\pm$ 1%		20 $\Omega$ (nom.) <sup>1</sup>

1. This value is defined without an extension cable.

### Measurement time

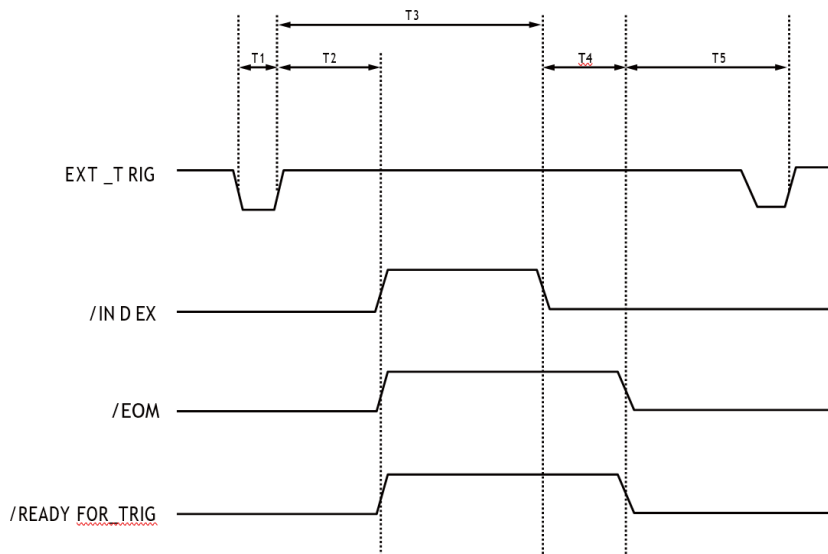

Figure 11. Timing chart and measurement time

Table 21 shows the values of T1 – T5 when the following conditions are met:

- Display update: Off
- Synchronous source: On
- Measurement range mode: Hold range mode (Hold)
- Source delay time: 0 ms
- Trigger delay time: 0 ms



- Averaging factor: 1
- SLC: Off
- Measurement time mode (N): 1
- Correction: On
- Multi connection: On
- LAN: Not connected

Table 21. Values of T1 – T5 (typical)

		Measurement frequency	Minimum value	Typical value
T1 Trigger pulse width		N/A	1 $\mu$ s	–
T2 Trigger response time of /READY_FOR_TRIG, /INDEX and /EOM		N/A	–	40 $\mu$ s
(T3 + T4) Measurement time	T3 Analog measurement time	120 Hz 1 kHz 1 MHz	– – –	10.0 ms 2.0 ms 1.3 ms
(T3 + T4) Measurement time	T4 Measurement computation time	N/A	–	1.0 ms
T5 Trigger wait time		N/A	0 $\mu$ Sec	–

## Display time

Except in the case of the DISPLAY BLANK page, the time required to update the display on each page (display time) is as follows (Table 22). When the screen is changed, drawing time and switching time are added. The measurement display is updated about every 100 ms.

Table 22. Display time

Item	Time
MEAS DISPLAY page drawing time	10 ms
MEAS DISPLAY page (large) drawing time	10 ms
BIN No. DISPLAY page drawing time	10 ms
BIN COUNT DISPLAY page drawing time	10 ms
Measurement display switching time	35 ms

Table 23 shows the measurement time (T3 + T4) for each measurement time mode.

Table 23. Measurement time

Frequency	Measurement time [ms]
120 Hz	$(N \times 8.3 \times Ave + 2.7) \pm 0.5$
1 kHz	$(N \times 1.0 \times Ave + 2.0) \pm 0.5$
1 MHz / 1 MHz $\pm$ 1% / 1 MHz $\pm$ 2%	$(N \times 1.0 \times (100/(100 + Fshift)) \times Ave + 1.3) \pm 0.5$

Measurement time mode (N) = 1, 2, 4, 6, 8

Ave: Averaging factor

Fshift: Frequency shift setting

### Measurement data transfer time

Table 24 shows the measurement data transfer time under the following conditions. The measurement transfer time varies with the measurement conditions and computer used.

- Host computer: DELL PRECISION 390, 1.86 GHz/Windows XP
- USB GPIB Interface Card: 82350A
- USB GPIB Interface: E2078A
- Display: ON
- Measurement range mode: Hold range mode (Hold)
- OPEN/SHORT/LOAD correction: OFF
- Measurement signal monitor: OFF
- BIN count function: OFF

Table 24. Measurement data transfer time (typical)

Interface	Data transfer format	Using: FETC? command (one point measurement)		Using: READ command (one point measurement)		Using data buffer memory (1000 measurement points(BUFFER3))	
		Comparator ON [ms]	Comparator OFF [ms]	Comparator ON [ms]	Comparator OFF [ms]	Comparator ON [ms]	Comparator OFF [ms]
GPIB	ASCII	1	1	3	3	202	186
	ASCII Long	1	1	3	3	247	231
	Binary	1	1	3	4	145	111
USB	ASCII	1	1	4	4	101	94
	ASCII Long	1	1	4	4	121	114
	Binary	1	1	4	4	43	33
LAN	ASCII	3	3	5	5	158	146
	ASCII Long	3	3	6	6	193	181
	Binary	5	5	7	7	105	79

# Measurement Assistance Functions

Table 25.

Measurement assistance functions	
Correction function	<ul style="list-style-type: none"> <li>• OPEN/SHORT/LOAD Correction are available</li> <li>• The OFFSET Correction is available</li> </ul>
MULTI Correction function	<ul style="list-style-type: none"> <li>• OPEN/SHORT/LOAD Correction for 256 channels</li> <li>• The LOAD Correction standard value can be defined for each channel</li> </ul>
Cable Correction function	Cable Correction is available
Deviation measurement function	Deviation from reference value and percentage of deviation from the reference value can be outputted as the result
Comparator function	<ul style="list-style-type: none"> <li>• BIN sort: The primary parameter can be sorted into 9 BINS, OUT_OF_BINS, AUX_BIN, and LOWC_OR_NC. The secondary parameter can be sorted into High, In, and Low.</li> <li>• Limit setup: An absolute value, deviation value, and % deviation value can be used for setup</li> <li>• Bin count: Countable from 0 to 999999</li> </ul>
Low C reject function	Extremely low measured capacitance values can be automatically detected as measurement errors
Contact check function	The contact check function is available on 120 Hz and 1 kHz
Single level compensation	<ul style="list-style-type: none"> <li>• SLC function compensates the voltage drop by the resistance inside the E4981A and the extension cable under the following frequencies and ranges</li> <li>• Measurement cable: 16048A or 16048D</li> <li>• When the measurement frequency is 120 Hz: 220 <math>\mu</math>F range, 470 <math>\mu</math>F range, 1 mF range</li> <li>• When the measurement frequency is 1 kHz: 22 <math>\mu</math>F range, 47 <math>\mu</math>F range, 100 <math>\mu</math>F range</li> </ul>

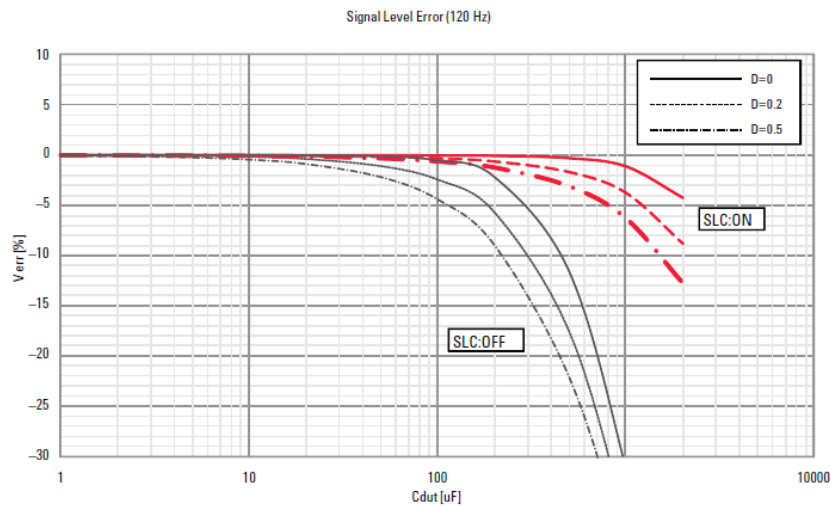

Figure 12.

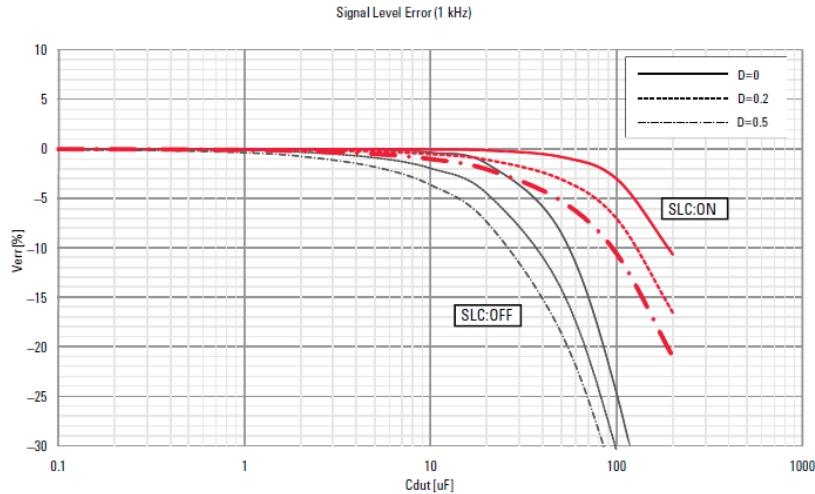

Figure 13.

Table 26.

Measurement assistance functions	
Measurement signal level monitor function	<ul style="list-style-type: none"> <li>Measurement voltage and measurement current can be monitored</li> <li>Level monitor accuracy (typical): <math>\pm (3\% + 1 \text{ mV})</math></li> </ul>
Data buffer function	Up to 1000 measurement results can be read out in batch
Save/recall function	<ul style="list-style-type: none"> <li>Up to 10 setup conditions can be written to/read from the built-in nonvolatile memory</li> <li>Up to 10 setup conditions can be written to/read from the external USB memory</li> <li>Auto recall function can be performed when the setting conditions are written to Register 9 in the built-in non-volatile memory</li> </ul>
Key lock function	The front panel keys can be locked
GPIB interface	Complies with IEEE488.1, 2 and SCPI
USB host port	<p>Universal serial bus jack, type-A (4 contact positions, contact 1 is on your left); female; for connection to USB memory device only</p> <p>Note: The following USB memory can be used.</p> <ul style="list-style-type: none"> <li>Complies with USB 1.1; mass storage class, FAT16/FAT32 format; maximum consumption current is below 500 mA</li> <li>Recommended USB memory: 4 GB USB Flash memory (Keysight PN 1819-0637)</li> <li>Use the prepared USB memory device exclusively for the E4981A; otherwise, other previously saved data may be cleared. If you use a USB memory other than the recommended device, data may not be saved or recalled normally.</li> <li>Keysight will NOT be responsible for data loss in the USB memory caused by using the E4981A</li> </ul>
USB interface port	<ul style="list-style-type: none"> <li>Universal serial bus jack, type mini-B (4 contact positions); complies with USBTMC-USB488 and USB 2.0; female; for connection to the external controller.</li> <li>USBTMC: Abbreviation for USB Test &amp; Measurement Class</li> </ul>

Measurement assistance functions						
LAN interface	<ul style="list-style-type: none"> <li>• 10/100 BaseT Ethernet, 8 pins; two speed options</li> <li>• Compliant with LXI standard (LAN eXtensions for Instrumentation): Version 1.2, Class C</li> <li>• Auto MDIX</li> </ul>					
Handler interface	<p>The input/output signals are negative logic and optically isolated open collector signals</p> <ul style="list-style-type: none"> <li>• Output signal: Bin1–Bin9, Out of Bins, Aux Bin, P-Hi, P-Lo, S-Reject, INDEX, EOM, Alarm, OVLD, Low C Reject or No Contact, Ready For Trigger</li> <li>• Input signal: Keylock, Ext-Trigger</li> </ul>					
Scanner interface	<p>The input/output signals are negative logic and optically isolated open collector signals</p> <ul style="list-style-type: none"> <li>• Output signal: INDEX, EOM</li> <li>• Input signal: Ch0 – Ch7, Ch valid, Ext-Trigger</li> </ul>					
Measurement circuit protection	<p>The maximum discharge withstand voltage, where the internal circuit remains protected if a charged capacitor is connected to the UNKNOWN terminal, is illustrated below. NOTE: Discharge capacitors before connecting them to the UNKNOWN terminal or a test fixture.</p>					
	<p>Maximum discharge withstand voltage (typical)</p> <table border="1"> <thead> <tr> <th>Maximum discharge withstand voltage</th> <th>Range of capacitance value C of DUT</th> </tr> </thead> <tbody> <tr> <td>1000 V</td> <td><math>C &lt; 2 \mu\text{F}</math></td> </tr> <tr> <td><math>\sqrt{2/C} \text{ V}</math></td> <td><math>C \geq 2 \mu\text{F}</math></td> </tr> </tbody> </table>	Maximum discharge withstand voltage	Range of capacitance value C of DUT	1000 V	$C < 2 \mu\text{F}$	$\sqrt{2/C} \text{ V}$
Maximum discharge withstand voltage	Range of capacitance value C of DUT					
1000 V	$C < 2 \mu\text{F}$					
$\sqrt{2/C} \text{ V}$	$C \geq 2 \mu\text{F}$					

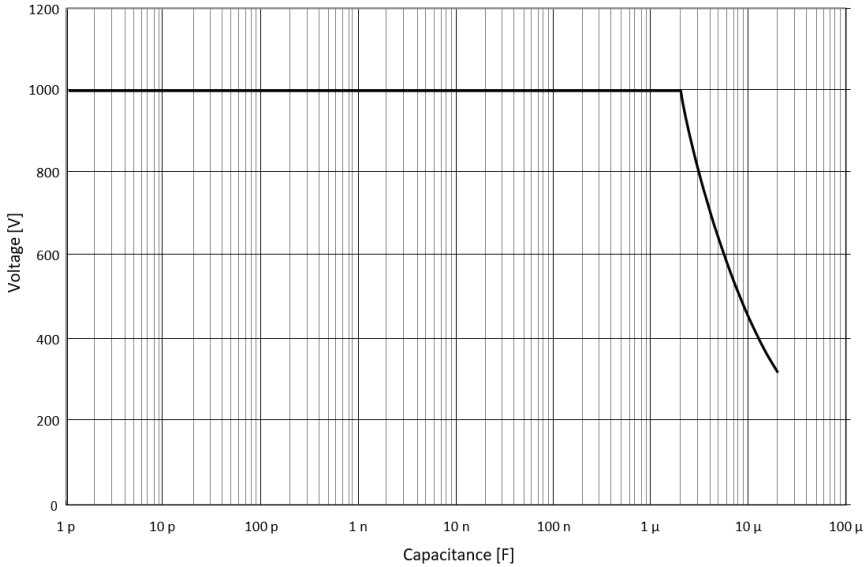

Figure 14. Maximum discharge withstands voltage (typical)

## General Specifications

Table 27.

Power source	
Rated voltage	115 – 230 VAC
Voltage range	90 – 264 VAC
Rated frequency	50 / 60 Hz
Frequency range	47 – 63 Hz
Power consumption	Maximum 150 VA

Table 28.

Operating environment	
Temperature	0 °C to 45 °C
Humidity ( $\leq 40$ °C, no condensation)	15% to 85% RH
Altitude	0 m to 2000 m

Table 29.

Storage environment	
Temperature	-20 °C to 70 °C
Humidity ( $\leq 65$ °C, no condensation)	0% to 90% RH
Altitude	0 m to 4572 m

Table 30.

Other	
Weight	4.3 kg (nominal)
Display	LCD, 320 x 240 (pixel), RGB color
Outer dimensions	370 (width) x 105 (height) x 405 (depth) mm (nominal)

Note: Effective pixels are more than 99.99%. There may be 0.01% or smaller missing pixels or constantly lit pixels, but this is not a malfunction.

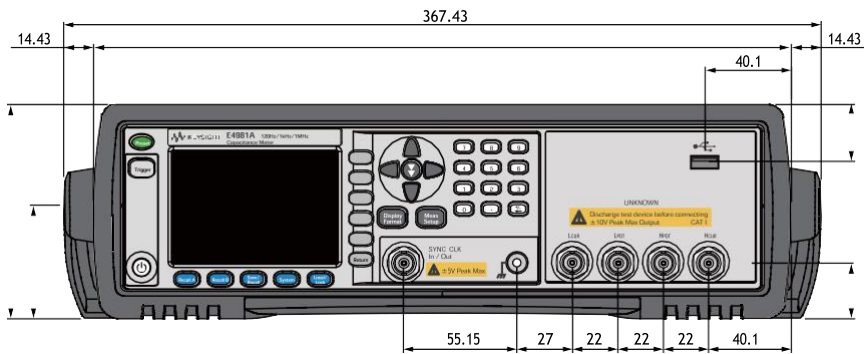

Figure 15. Dimensions (front view, with handle and bumper, in millimeters, nominal)

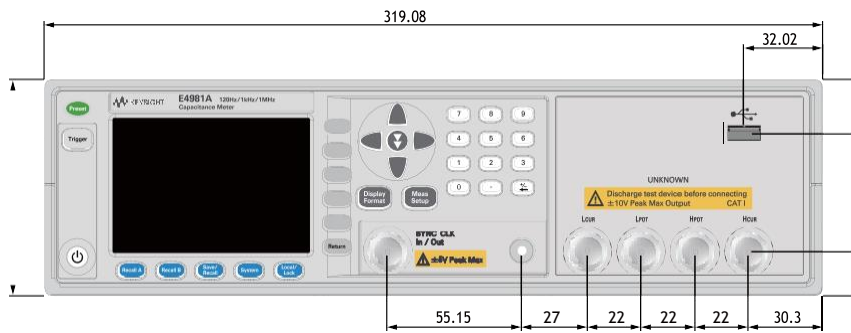

Figure 16. Dimensions (front view, without handle and bumper, in millimeters, nominal)

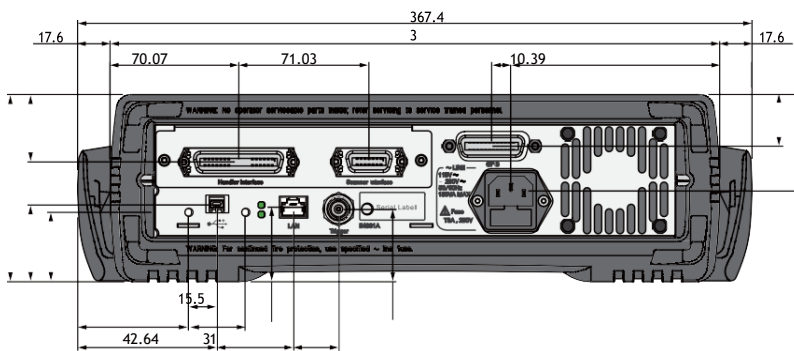

Figure 17. Dimensions (rear view, with handle and bumper, in millimeters, nominal)

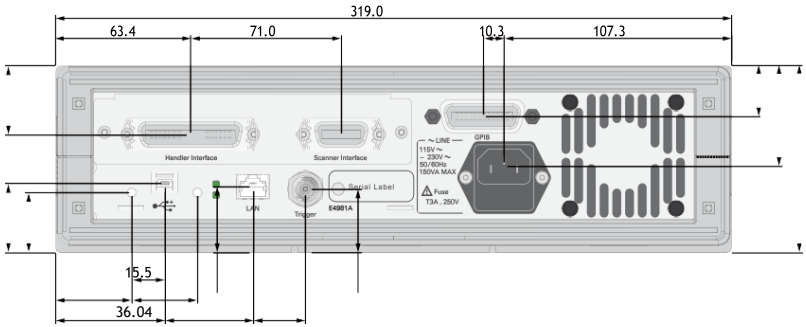

Figure 18. Dimensions (rear view, without handle and bumper, in millimeters, nominal)

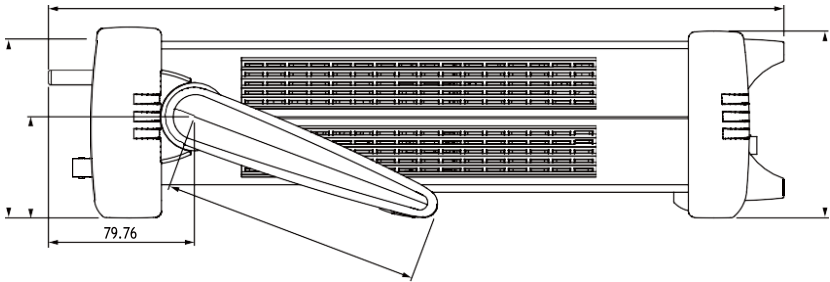

Figure 19. Dimensions (side view, with handle and bumper, in millimeters, nominal)

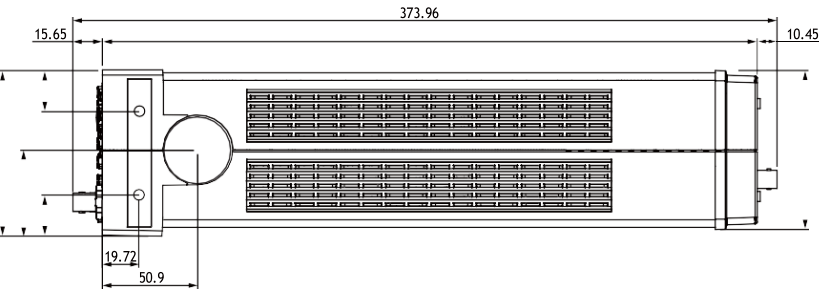





Figure 20 (19). Dimensions (side view, without handle and bumper, in millimeters, nominal)



# EMC, Safety, Environment and Compliance

Table 31.

EMC <sup>1</sup>		
Description	Specification	
Complies with the essential requirements of the European EMC Directive as well as current editions of the following standards (dates and editions are cited in the Declaration of Conformity).		
 ISM 1-A	The CE mark is a registered trademark of the European Community (if accompanied by a year, it is the year when the design was proven). This product complies with all relevant directives. – IEC 61326-1 – CISPR 11 Group 1, Class A	
	UK conformity mark is a UK government owned mark. When affixed to the product is declaring all applicable Directives and Regulations have been met in full.	
CAN ICES/NMB-001(A)	This ISM device complies with Canadian ICES-001. Cet appareil ISM est conforme a la norme NMB du Canada.	
	The RCM mark is a registered trademark of the Australian Communications and Media Authority. – AS/NZS CISPR 11	
	South Korean Certification (KC) mark; includes the marking's identifier code: R-R-Kst-xxxxxx  South Korean Class A EMC declaration: Information to the user: This equipment has been conformity assessed for use in business environments. In a residential environment this equipment may cause radio interference. ※ This EMC statement applies to the equipment only for use in business environment.	
	<table border="1"> <tr> <td>                             사용자 안내문                              이 기기는 업무용 환경에서 사용할 목적으로 적합성평가를 받은 기기로서 가정용 환경에서 사용하는 경우 전파간섭의 우려가 있습니다.                         </td> </tr> </table> ※ 사용자 안내문은 “업무용 방송통신기자재”에만 적용한다.	사용자 안내문 이 기기는 업무용 환경에서 사용할 목적으로 적합성평가를 받은 기기로서 가정용 환경에서 사용하는 경우 전파간섭의 우려가 있습니다.
사용자 안내문 이 기기는 업무용 환경에서 사용할 목적으로 적합성평가를 받은 기기로서 가정용 환경에서 사용하는 경우 전파간섭의 우려가 있습니다.		



## EMC, Safety, Environment and Compliance

Table 32.

Safety <sup>1</sup>	
Description	Specification
<p>Complies with the essential requirements of the European Low Voltage Directive as well as current editions of the following standards (dates and editions are cited in the Declaration of Conformity).                      This product is designed for use in INSTALLATION CATEGORY II and POLLUTION DEGREE 2 and MEASUREMENT CATEGORY NONE per IEC standards.                      This product is intended for indoor use.</p>	
 ISM 1-A	IEC 61010-1
 C US	The CSA mark is a registered trademark of the CSA International. – Canada: CSA C22.2 No. 610610-1 – USA: UL std no. 61010-1

1. To find a current Declaration of Conformity for a specific Keysight product, go to: <http://www.keysight.com/go/conformity>.

Table 33.

Environment	
WEEE	
 	<p>The crossed out wheeled bin symbol indicates that separate collection for waste electric and electronic equipment (WEEE) is required, as obligated by DIRECTIVE 2012/19/EU.</p> <p>Please refer to <a href="http://about.keysight.com/en/companyinfo/environment/takeback.shtml">about.keysight.com/en/companyinfo/environment/takeback.shtml</a> to understand your Trade in options with Keysight in addition to product takeback instructions.</p>

## Sample Calculation of Measurement Accuracy

This section describes an example for calculating the measurement accuracy of each measurement parameter, assuming the following measurement conditions.

### Sample

- Measurement signal frequency: 1 kHz
- Measurement signal level: 0.5 V
- Measurement range: 10 nF
- Measurement time mode: N = 1
- Ambient temperature: 28°C

### When measurement parameter is Cp-D (or Cs-D)

The following is an example for calculating the accuracy of Cp (or Cs) and D, assuming that measured result of Cp (or Cs) is 8.00000 nF and measured result of D is 0.01000.

From Table 13, the equation to calculate the accuracy of Cp (or Cs) is  $0.055 + 0.030 \times K$  and the equation to calculate the accuracy of D is  $0.00035 + 0.00030 \times K$

The measurement signal level is 0.5, the measurement range is 10 nF, and the measured result of Cp (or Cs) is 8.00000 nF. Therefore,  $K = (1/0.5) \times (10/8.00000) = 2.5$

Substitute this result into the equation. As a result, the accuracy of Cp (or Cs) is  $0.055 + 0.030 \times 2.5 = 0.13\%$  and the accuracy of D is  $0.00035 + 0.00030 \times 2.5 = 0.0011$

Therefore, the true Cp (or Cs) value exists within  $8.00000 \pm (8.00000 \times 0.13/100) = 8.00000 \pm 0.0104$  nF that is,

7.9896 nF to 8.0104 nF and the true D value exists within  $0.01000 \pm 0.0011$  that is, 0.0089 to 0.0111

### When measurement parameter is Cp-Q (or Cs-Q)

The following is an example for calculating the accuracy of Cp (or Cs) and Q, assuming that measured result of Cp (or Cs) is 8.00000 nF and measured result of Q is 20.0.

The accuracy of Cp (or Cs) is the same as that in the example of Cp-D. From Table 14, the equation to calculate the accuracy of D is  $0.00035 + 0.00030 \times K$

Substitute  $K = 2.5$  (same as Cp-D) into this equation.

The accuracy of D is  $0.00035 + 0.00030 \times 2.5 = 0.0011$

Then, substitute the obtained D accuracy into Equation 1.

The accuracy of Q is  $\pm(20.0)^2 \times 0.0011 / (1 \mp 20.0 \times 0.0011) = \pm 0.44 / (1 \mp 0.022)$

that is, -0.43 to 0.45

Therefore, the true Q value exists within the range of 19.57 to 20.45

### When measurement parameter is Cp-G

The following is an example for calculating the accuracy of Cp and G, assuming that measured result of Cp is 8.00000 nF and measured result of G is 1.00000 μS. The accuracy of Cp is the same as that in the example of Cp-D.

From Table 12, the equation to calculate the accuracy of G is  $(C_e/100) \times 2 \times \pi \times f \times C_x$

Substitute  $C_e = 0.13\%$  (same as Cp-D) and  $C_x = 8.00000$  nF of the measured Cp result into this equation. The accuracy of G is  $(0.13/100) \times 2 \times \pi \times 1 \times 10^3 \times 8 \times 10^{-9} = 65.35$  nS (0.065 μS)

Therefore, the true G value exists within  $1.00000 \pm 0.065$  μS that is, 0.935 μS to 1.065 μS

### When measurement parameter is Cp-Rp

The following is an example for calculating the accuracy of Cp and Rp, assuming that measured result of Cp is 8.00000 nF and measured result of Rp is 2.00000 MΩ.

The accuracy of Cp is the same as that in the example of Cp-D. From Table 12 the equation to calculate the accuracy of Rp is

$$\frac{\pm R_{px}^2 \times G_e}{1 \mp R_{px} \times G_e}$$

Substitute  $R_{px} = 2.00000$  MΩ of the measured Rp result into this equation.

The accuracy of G is  $(0.13/100) \times 2 \times \pi \times 1 \times 10^3 \times 8 \times 10^{-9} = 65.35$  nS (0.065 μS)

Then, substitute the obtained G accuracy into 1st Equation. The accuracy of Rp is

$$\frac{\pm 2M^2 \times 0.065\mu}{1 \mp 2M \times 0.065\mu}$$

that is,  $-0.23009$  MΩ to  $0.29885$  MΩ

Therefore, the true Rp value exists within  $1.76991$  MΩ to  $2.29885$  MΩ

### When measurement parameter is Cs-Rs

The following is an example for calculating the accuracy of Cs and Rs, assuming that measured result of Cs is 8.00000 nF and measured result of Rs is 4.00000 kΩ. Because the Cs accuracy is

$$D = 2 \times \pi \times \text{Freq} \times C_s \times R_s = 2 \times \pi \times 1 \times 10^3 \times 8 \times 10^{-9} \times 4 \times 10^3 = 0.2 \quad (0.1 < D \leq 0.5)$$

multiply 0.13% (the result obtained for Cs-D) by  $1 + D^2$ .

The result is  $0.13 \times (1 + 0.22) = 0.1352\%$

From Table 12 the equation to calculate the accuracy of Rs is  $(C_e/100) / (2 \times \pi \times f \times C_x)$

Substitute  $C_e = 0.1352\%$  (Cs accuracy calculated above) and  $C_x = 8.00000$  nF of the measured Cs result into this equation. The accuracy of Rs is

$$(0.1352/100) / (2 \times \pi \times 1 \times 10^3 \times 8 \times 10^{-9}) = 26.897$$

Because  $(0.1 < D \leq 0.5)$ , multiply the result by  $1 + D^2$  similar as in the case of Cs.

The final result is 27.97  $\Omega$ .

Therefore, the true Cs value exists within

$$8.00000 \pm (8.00000 \times 0.1352/100) = 8.00000 \pm 0.01082 \text{ nF that is,}$$

7.98918 nF to 8.01082 nF and the true Rs value exists within  $4.00000 \pm 0.02797$  k $\Omega$  that is,

3.97203 to 4.02797 k $\Omega$

[www.keysight.com/find/e4981a](http://www.keysight.com/find/e4981a)

Learn more at: [www.keysight.com](http://www.keysight.com)

For more information on Keysight Technologies' products, applications or services, please contact your local Keysight office. The complete list is available at: [www.keysight.com/find/contactus](http://www.keysight.com/find/contactus)

