

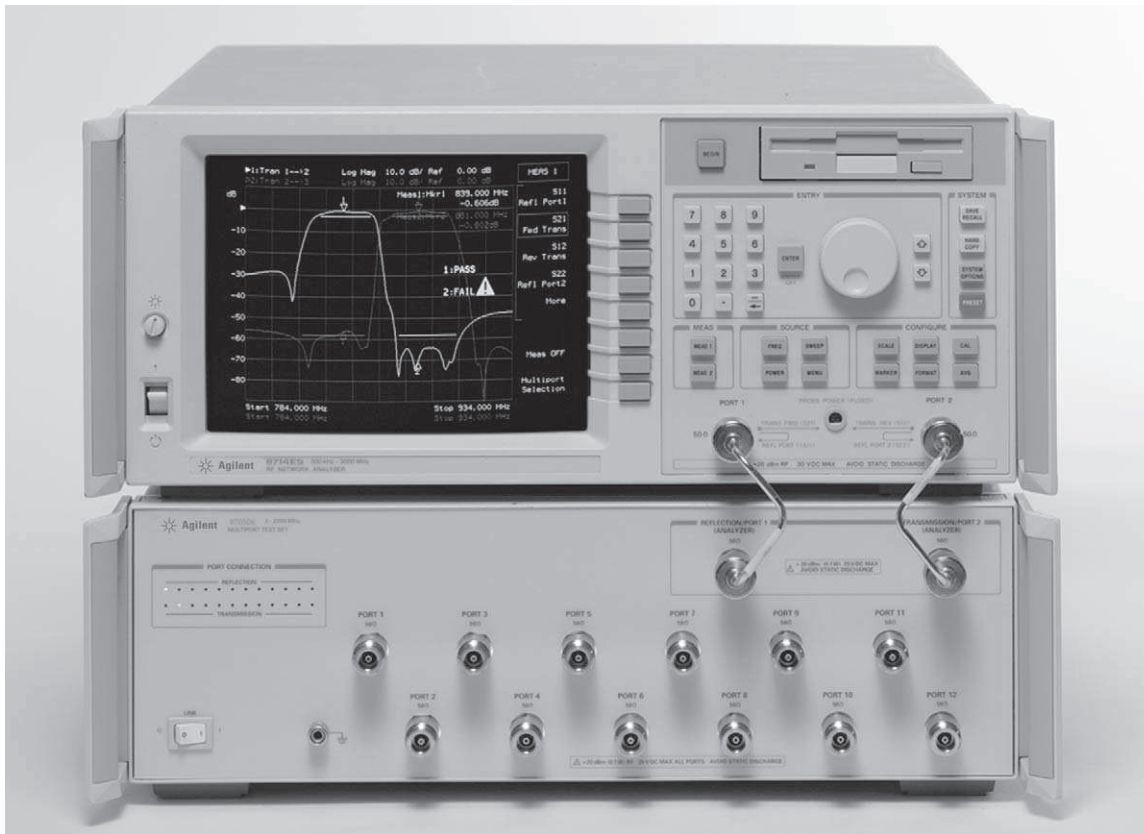

# Agilent 87050E

## 50 Ohm Multiport Test Sets

Data Sheet



### Agilent 87050E 3 MHz to 2.2 GHz

This document describes the performance and features of Agilent Technologies 87050E 50 ohm multiport test sets, both as standalone units and when combined with 50 ohm 8712ET, 8712ES, 8714ET, or 8714ES network analyzers. The following options are available:

- Option 004 (4 ports)
- Option 008 (8 ports)
- Option 012 (12 ports)

For more information about these test sets, please read the following documents:

- *Agilent 87050E*, brochure, literature number, 5968-4763E
- *Agilent 87050E*, configuration guide, literature number, 5968-4765E



**Agilent Technologies**

# Introduction

All specifications and characteristics apply over a  $25\text{ }^{\circ}\text{C} \pm 5\text{ }^{\circ}\text{C}$  range (unless otherwise stated) and 30 minutes after the instrument has been turned on.

## Definitions

### Specification:

Warranted performance. Specifications include guardbands to account for the expected statistical distribution, measurement uncertainties, and changes in performance due to environmental conditions.

### Characteristic:

A performance parameter that the product is expected to meet before it leaves the factory, but is not verified in the field and is not covered by the product warranty. A characteristic includes the same guardbands as a specification.

### Typical:

Expected performance of an average unit. A typical does not include guardbands. It is not covered by the product warranty.

### Nominal:

A general, descriptive term that does not imply a level of performance. It is not covered by the product warranty.

### Supplemental information:

May include typical, nominal, or characteristic values.

### Calibration:

The process of measuring known standards from a calibration kit to characterize the systematic (repeatable) errors of a network analyzer.

### Corrected (residual) performance:

Indicates performance after error correction (calibration). It is determined by the quality of calibration standards and how well “known” they are, plus system repeatability, stability, and noise.

### Uncorrected (raw) performance:

Indicates instrument performance without error correction. The uncorrected performance affects the stability of a calibration.

### System performance:

Performance of a complete multiport test system, which includes an 87050E test set and an 8712ET/ES or 8714ET/ES network analyzer.

### Test Set Cal:

The calibration of a multiport test system, requiring the connection of known calibration standards to all of the ports that will be used for measurements.

### SelfCal:

An automated system calibration that uses calibration standards internal to the test set and the most recent Test Set Cal data to calibrate the test system.

### Environmental specifications:

Environmental specifications bound the external conditions for which the specifications are valid. The environmental specifications also bound the external conditions the test set may be subject to without permanently affecting performance or causing physical damage.

## Table of contents

3	System performance, two-port calibration
5	System performance, T/R calibration
8	System performance, uncorrected
9	System performance, general
12	Test set input/output performance
13	Test set general information
14	Physical dimensions
15	Block diagrams
16	System features

# System performance

## Two-port calibration (user)

### Agilent 85032B/E Type-N calibration kit

Parameter	Specification <sup>1</sup> (dB)		Typical <sup>2</sup> (dB)
	3 MHz to 1.3 GHz	1.3 GHz to 2.2 GHz	2.2 GHz to 3 GHz
Directivity	47	40	37
Source match	37	35	30
Load match	47	40	37
Reflection tracking	±0.1	±0.1	±0.2
Transmission tracking	±0.1	±0.1	±0.2

### Transmission uncertainty (typical)<sup>3</sup>

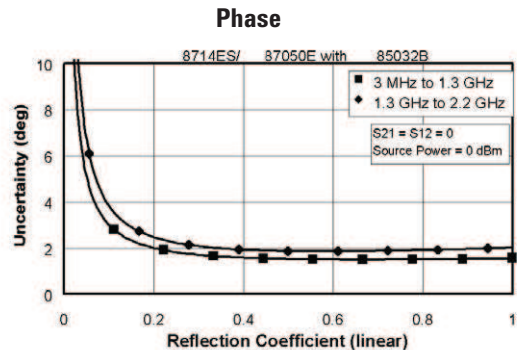
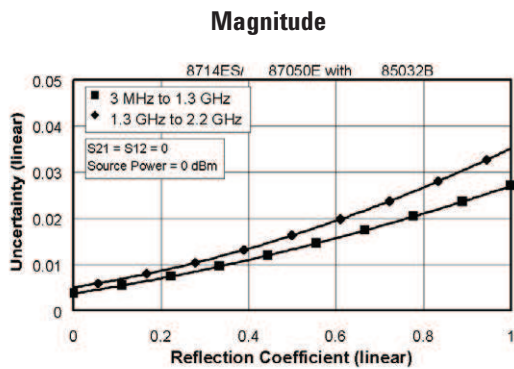
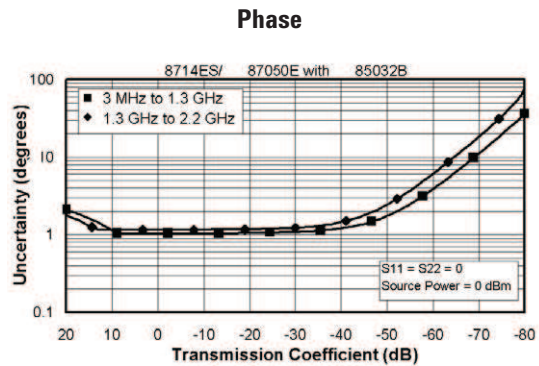
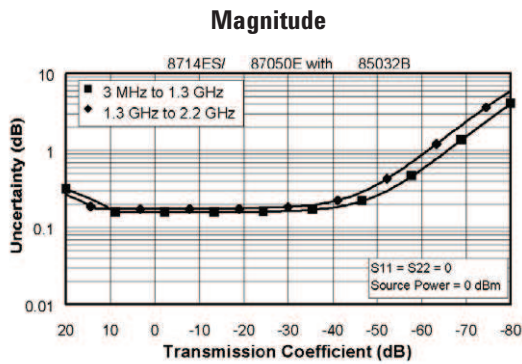

1. These specifications and supplementals apply under the following conditions: measurement uses the "Fine" (15 Hz) bandwidth, no averaging, and isolation cal "on"; Test Set Cals use the "Fine" (15 Hz) bandwidth, 16 averages, and assume an isolation calibration has been performed; the test set must be used with an 8712ES or 8714ES network analyzer with firmware revision E.06.00 or later; the test set and the analyzer must have had their performance verified within the last year; both instruments must have warmed up for at least 30 minutes after turn-on; measurements are made at an environmental temperature of 25 °C ± 5 °C and within ± 1 °C of the last valid Test Set Cal.
2. Corrected system performance is changed to typical when the current temperature has drifted beyond ± 1 °C of the last valid Test Set Cal. Typical values are valid only when the current temperature is within 25 °C ± 5 °C, and within ± 1 °C of the most recent SelfCal.
3. These uncertainty curves only include the effects of the test port(s) within the measurement path. The effect of the uncorrected match of test ports outside the measurement path is ignored, and is dependent on the isolation between the ports of the DUT that are within the measurement path and ports of the DUT that are outside the measurement path.

# System performance

## Two-port calibration (user)

### Agilent 85033D 3.5mm calibration kit

Parameter	Specification <sup>1</sup> (dB)		Typical <sup>2</sup> (dB)
	3 MHz to 1.3 GHz	1.3 GHz to 2.2 GHz	2.2 GHz to 3 GHz
Directivity	40	38	35
Source match	38	35	30
Load match	40	38	35
Reflection tracking	±0.1	±0.1	±0.2
Transmission tracking	±0.1	±0.1	±0.2

### Transmission uncertainty (typical)<sup>3</sup>

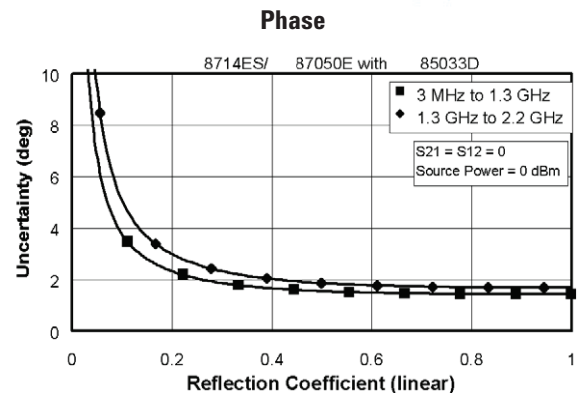
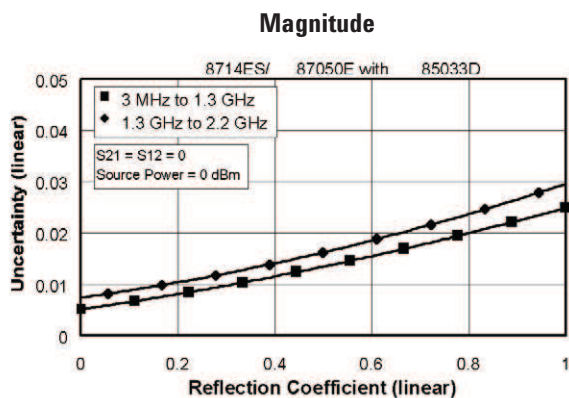
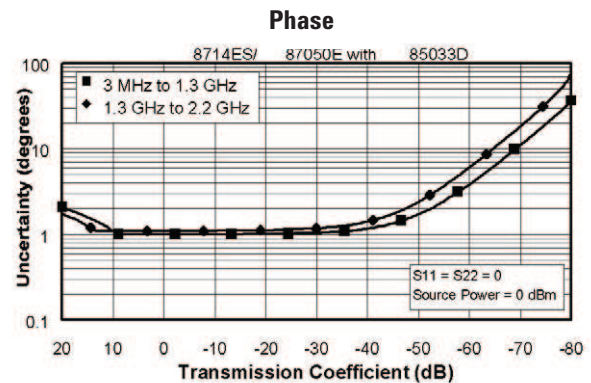
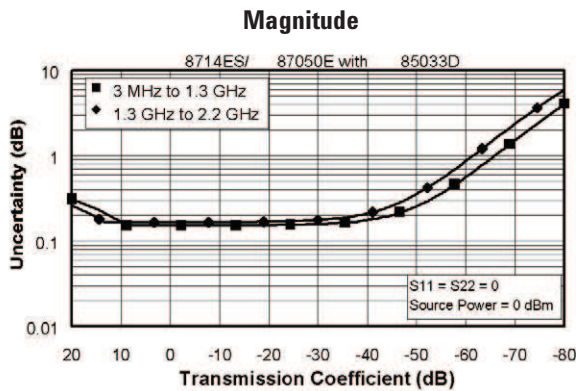

1. These specifications and supplementals apply under the following conditions: measurement uses the "Fine" (15 Hz) bandwidth, no averaging, and isolation cal "on"; Test Set Cals use the "Fine" (15 Hz) bandwidth, 16 averages, and assume an isolation calibration has been performed; the test set must be used with an 8712ES or 8714ES network analyzer with firmware revision E.06.00 or later; the test set and the analyzer must have had their performance verified within the last year; both instruments must have warmed up for at least 30 minutes after turn-on; measurements are made at an environmental temperature of 25 °C ± 5 °C and within ± 1 °C of the last valid Test Set Cal.
2. Corrected system performance is changed to typical when the current temperature has drifted beyond ± 1 °C of the last valid Test Set Cal. Typical values are valid only when the current temperature is within 25 °C ± 5 °C, and within ± 1 °C of the most recent SelfCal.
3. These uncertainty curves only include the effects of the test port(s) within the measurement path. The effect of the uncorrected match of test ports outside the measurement path is ignored, and is dependent on the isolation between the ports of the DUT that are within the measurement path and ports of the DUT that are outside the measurement path.

# System performance

## Transmission/reflection (T/R) calibration (user)

### Agilent 85032B/E Type-N calibration kit

Parameter	Specification <sup>1</sup> ( dB)		Typical <sup>2</sup> (dB)		
	3 MHz to 1.3 GHz	1.3 GHz to 2.2 GHz	3 MHz to 1.3 GHz	1.3 GHz to 2.2 GHz	2.2 GHz to 3 GHz
Directivity	47	40	—	—	40
Source match	37	32	—	—	30
Load match (reflection calibration)	18	18	23	24	20
Load match (transmission calibration)	14	14	18	18	14
Reflection tracking	±0.1	±0.1	—	—	±0.2
Transmission tracking	±0.1	±0.1	—	—	±0.2

1. These specifications and supplementals are valid for reflection (one-port) and transmission (enhanced-response) Test Set Cals, and apply under the following conditions: measurement uses the "Fine" (15 Hz) bandwidth, no averaging, and isolation cal "on"; Test Set Cals use the "Fine" (15 Hz) bandwidth, 16 averages, and assume an isolation calibration has been performed; the test set must be used with an 8712ET, 8712ES, 8714ET, or 8714ES network analyzer with firmware revision E.06.00 or later; the test set and the analyzer must have had their performance verified within the last year; both instruments must have warmed up for at least 30 minutes after turn-on; measurements are made at an environmental temperature of 25 °C ± 5 °C and within ± 1 °C of the last valid Test Set Cal.
2. Corrected system performance is changed to typical when the current temperature has drifted beyond ± 1 °C of the last valid Test Set Cal. Typical values are valid only when the current temperature is within 25 °C ± 5 °C, and within ± 1 °C of the most recent SelfCal.



# System performance

## Transmission/reflection (T/R) calibration (user)

### Agilent 85032B/E Type-N calibration kit (continued) Transmission uncertainty, enhanced response calibration (typical)<sup>1</sup>

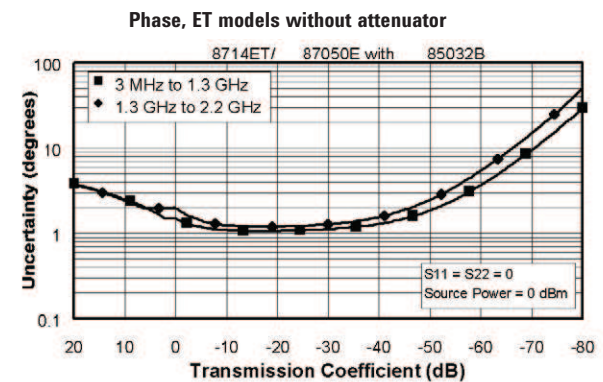
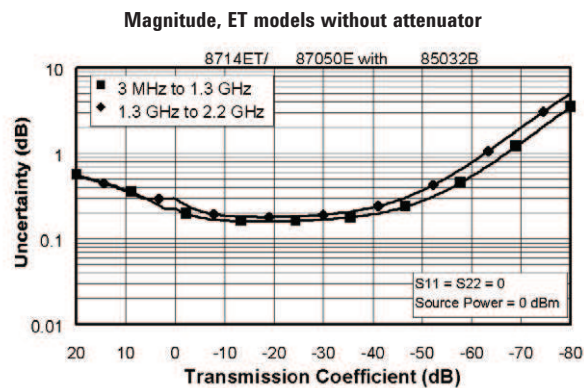
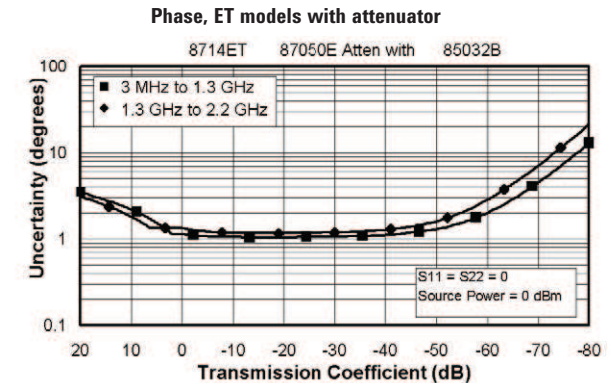
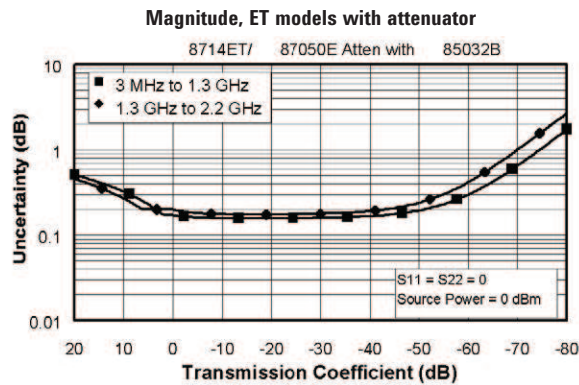
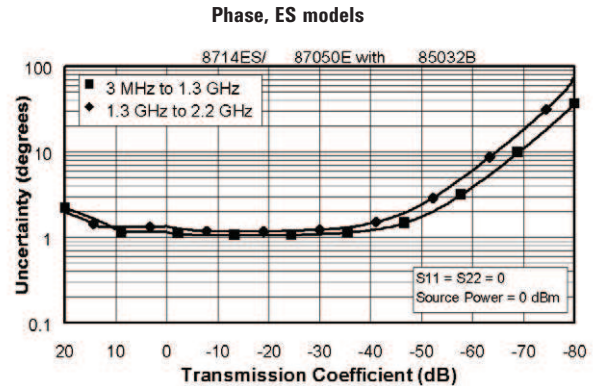
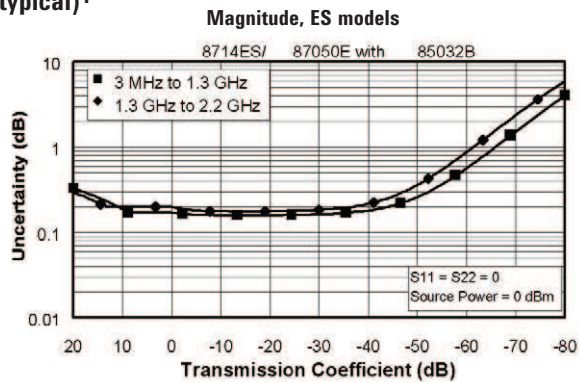

1. These uncertainty curves only include the effects of the test port(s) within the measurement path. The effect of the uncorrected match of test ports outside the measurement path is ignored, and is dependent on the isolation between the ports of the DUT that are within the measurement path and ports of the DUT that are outside the measurement path.

# Agilent 85032B/E Type-N calibration kit

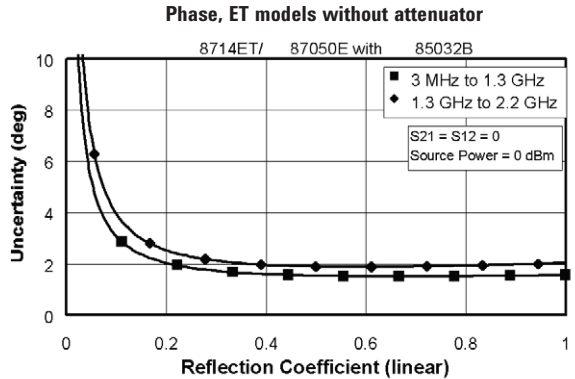
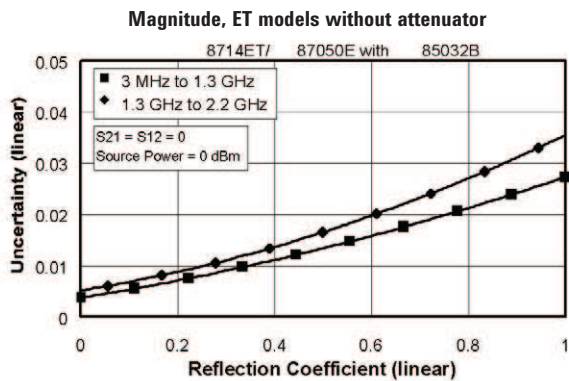
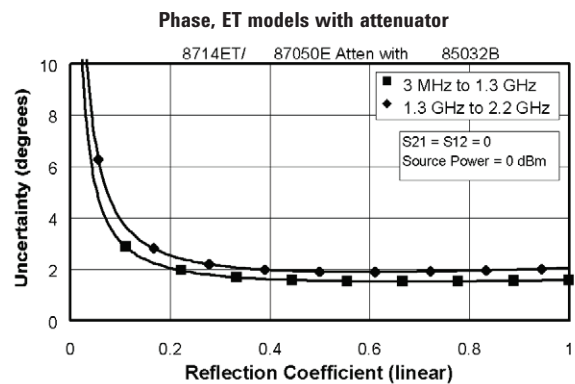
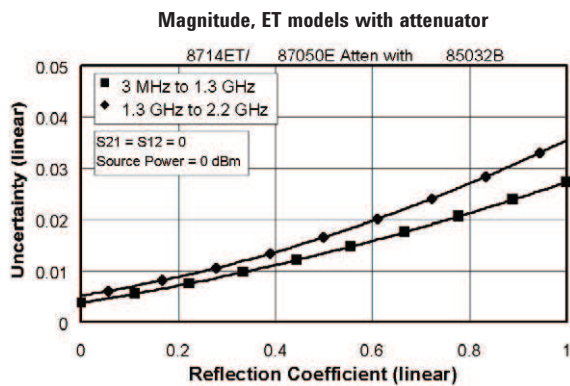
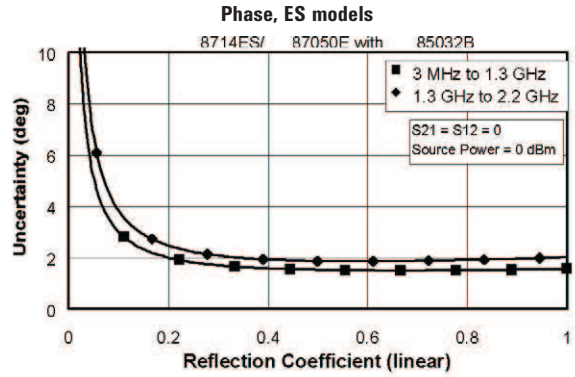
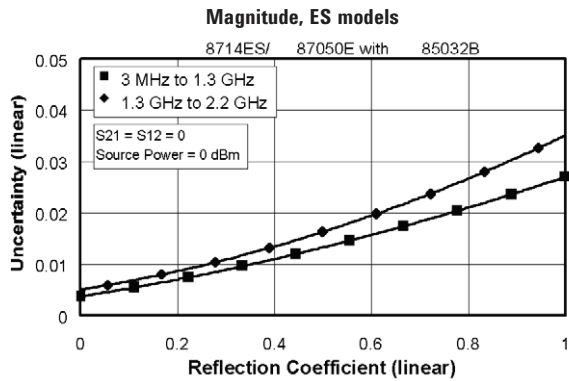

1. These uncertainty curves only include the effects of the test port(s) within the measurement path. The effect of the uncorrected match of test ports outside the measurement path is ignored, and is dependent on the isolation between the ports of the DUT that are within the measurement path and ports of the DUT that are outside the measurement path.

# System performance

## Uncorrected

### Type-N

Parameter	Specification1 ( dB)		Typical (dB)		
	3 MHz to 1.3 GHz	1.3 GHz to 2.2 GHz	3 MHz to 1.3 GHz	1.3 GHz to 2.2 GHz	2.2 GHz to 3 GHz
Source match, ratioed	12	10	17	14	11
Load match, test port unselected <sup>2</sup>	18	18	23	24	20
Load match, test port selected <sup>3</sup>	12	12	16	17	13
Transmission tracking <sup>4</sup>	—	—	±3	±2.5	±3
Reflection tracking <sup>4</sup>	—	—	±3	±2.5	±3
Crosstalk <sup>5</sup> , 8712ET/8714ET	—	—	93	89	81
Crosstalk <sup>5</sup> , 8712ES/8714ES	—	—	83	79	71

1. These specifications and supplementals apply under the following conditions: measurement uses the “Fine” (15 Hz) bandwidth, with narrowband detection and no averaging; the test set must be used with an 8712ET, 8712ES, 8714ET, or 8714ES network analyzer with firmware revision E.06.00 or later; the test set and the analyzer must have had their performance verified within the last year; both instruments must have warmed up for at least 30 minutes after turn-on.
2. This is the match of any test port that is unselected (not in the measurement path). If the network analyzer is performing a reflection measurement with one-port calibration, then only one port on the test set is selected (the source port). If the network analyzer is performing a transmission measurement or a reflection measurement with two-port calibration, then only two ports on the test set are selected (the source and load ports).
3. This is the match of the test set port that has been selected as the load port. The network analyzer must be making a transmission measurement or a reflection measurement with two-port calibration for a test port to be selected as the load port.
4. The uncorrected tracking terms are defined as the deviation over the defined frequency band, ignoring offset loss.
5. Crosstalk is computed by normalizing the result of an isolation measurement to a through measurement between the two ports such that the path losses are taken into account. Isolation is defined as the transmission signal measured between any two ports of the test system when those two ports are terminated with shorts.



# System performance

## General

Specification	Typical							
	System bandwidth							
	Fine 15 Hz		Fine 15 Hz		Med Wide 4000 Hz		Wide 6500 Hz	
<b>Network analyzer</b>	<b>3 MHz to 1.3 GHz</b>	<b>1.3 GHz to 2.2 GHz</b>	<b>3 MHz to 1.3 GHz</b>	<b>1.3 GHz to 2.2 GHz</b>	<b>3 MHz to 1.3 GHz</b>	<b>1.3 GHz to 2.2 GHz</b>	<b>3 MHz to 1.3 GHz</b>	<b>1.3 GHz to 2.2 GHz</b>
	System noise floor <sup>1</sup> (dBm)							
8712ET/8714ET	-97	-95	-106	-103	-82	-79	-42	-39
8712ES/8714ES	-88	-86	-100	-97	-75	-72	-42	-39
	System dynamic range <sup>2</sup> (dB)							
8712ET, no attenuator	101	97	112	108	87	83	49	45
8712ET, with attenuator	100	96	111	107	86	82	48	44
8712ES	89	85	103	99	78	74	45	41
8714ET, no attenuator	99	95	109	105	84	80	46	42
8714ET, with attenuator	97	93	108	104	83	79	45	41
8714ES	86	82	100	96	81	77	42	38

1. Noise floor is defined as the rms value of the trace (in linear format) for a transmission measurement in CW mode, using the "Fine" bandwidth (15 Hz), the test ports terminated in loads, 0 dBm at the test set source port, and no averaging. This measurement ignores the effects of crosstalk. This is a system specification—the test set increases the network analyzer noise floor by adding loss to the network analyzer measurement.

2. The system dynamic range is calculated as the difference between the receiver minimum input (noise floor plus calibrated crosstalk) and the system's maximum output power. System dynamic range applies to transmission measurements only, since reflection measurements are limited by directivity.

# System performance

## General (continued)

	Specification		Supplemental information	
<b>System bandwidth</b>				
<b>Network analyzer</b>	<b>Fine</b>	<b>Fine</b>	<b>Med Wide</b>	<b>Wide</b>
	<b>15 Hz</b>	<b>15 Hz</b>	<b>4000 Hz</b>	<b>6500 Hz</b>
<b>Receiver dynamic range<sup>1</sup> (dB)</b>				
8712ET/8714ET	115	121	96	58
8712ES/8714ES	106	115	90	57

**Magnitude, ES models**

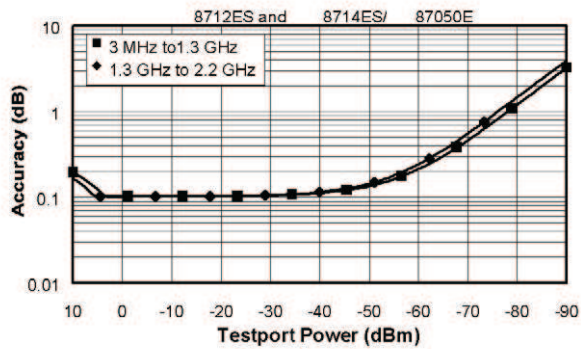

**Phase, ES models**

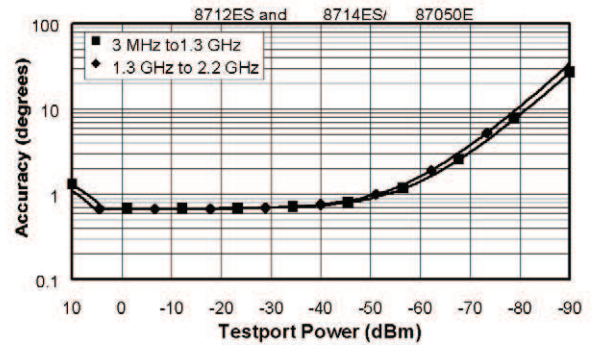

**Magnitude, ET models**

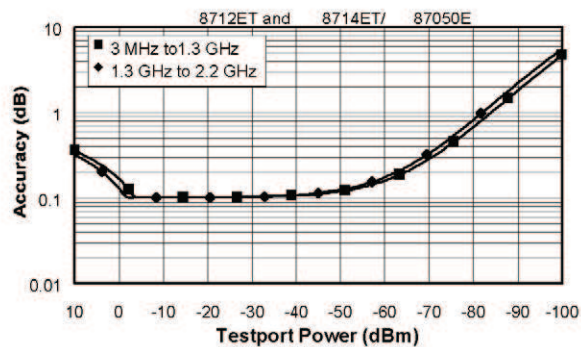

**Phase, ET models**

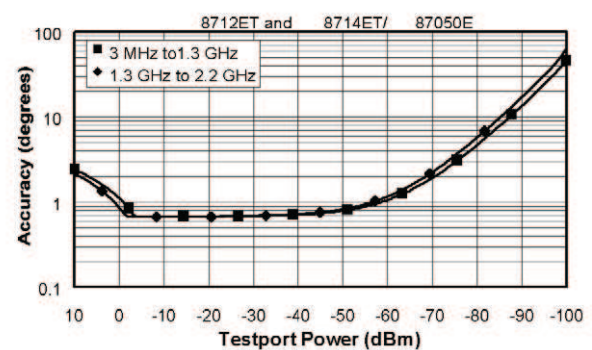

1. The receiver dynamic range is calculated as the difference between the receiver minimum input (noise floor) and the receiver maximum input. Receiver dynamic range applies to transmission measurements only, since reflection measurements are limited by directivity.

2. The reference power for dynamic accuracy is -20 dBm.

Network analyzer	Specification	Characteristic (dBm)	
		<1 GHz	>1 GHz
<b>Output power (system maximum)</b>			
8712ET, no attenuator	—	10.5	7
8712ET, with attenuator	—	9.5	6
8712ES	—	7.5	4
8714ET, no attenuator	—	5.5	2
8714ET, with attenuator	—	4.5	1
8714ES	—	3.5	-1

Parameter	Specification	Supplemental information
Reflection calibration	—	0.7
Transmission enhanced calibration	—	0.7
Two-port calibration	—	0.7
<b>SelfCal time<sup>2</sup> (sec)</b>		
Reflection calibration	—	1 (typical)
Transmission enhanced calibration	—	3 (typical)
Two-port calibration	—	8 (typical)

1. This is the time required to switch to any new port configuration, and requires that the Test Set Cal has been performed for 201 points, the new measurement configuration is 201 points, and no new SelfCal occurs during switching.

2. This is the time required to perform the SelfCal for any single port configuration, assuming that the Test Set Cal was performed for 201 points, the new measurement configuration is 201 points, and the measurement bandwidth is "Med Wide" (4000 Hz). SelfCal times for other settings can be found in Table 4-1 of the Agilent 87050E/87075C Users and Service Guide (87050-90026).

# Test set input/output performance

Parameter	Specification	Supplemental
Frequency range	3 MHz to 2.2 GHz	—
<b>RF input power</b>		
Maximum input power at 0.1 dB compression <sup>1</sup>	—	16 dBm (nominal)
Input damage power	—	20 dBm (characteristic)

Parameter	Specification (dB)		Typical (dB)		
	3 MHz to 1.3 GHz	1.3 GHz to 2.2 GHz	3 MHz to 1.3 GHz	1.3 GHz to 2.2 GHz	2.2 GHz to 3 GHz
Source match, test port <sup>2</sup>	14	11	18	15	12
Load match, test port unselected <sup>3</sup>	18	18	23	24	20
Load match, test port selected <sup>4</sup>	14	14	18	18	14
Interconnect match, reflection port <sup>5</sup>	12	10	17	15	10
Interconnect match, transmission port <sup>5</sup>	11	8	14	13	11
Insertion loss, reflection port to port-n <sup>6</sup>	7.5	9.5	6	8	12
Insertion loss, transmission port to port-n <sup>6</sup>	7.5	9.5	6	8	12
Tracking, reflection port to port-n <sup>6</sup>	—	—	1.5	1.2	1.5
Tracking, transmission port to port-n <sup>6</sup>	—	—	1.5	1.2	1.5
Crosstalk, uncalibrated, adjacent ports <sup>7</sup>	90	90	100	95	85
Crosstalk, uncalibrated, non-adjacent ports <sup>7</sup>	90	90	105	100	90

1. Compression is defined for the test set, independent of the network analyzer.

2. This is the match of the test set port that has been selected as the source port. The test set interconnect reflection port must be terminated with a load standard from an Agilent 85032B/E calibration kit.

3. This is the match of any test port that is unselected (not in the measurement path). Only the source port of the test set is selected when you make a reflection measurement with one-port calibration. Only the source and load ports of the test set are selected when you make a transmission measurement, or a reflection measurement with two-port calibration.

4. This is the match of the test set port that has been selected as the load port. A transmission or two-port measurement is required for a test port to be selected as the load port. The test set interconnect transmission port must be terminated with a load standard from an 85032B/E calibration kit.

5. This is the match of the test set interconnect ports (transmission and reflection ports) with the test set in transmission, or two-port mode. The selected test set test ports must be terminated with load standards from 85032B/E calibration kits.

6. The reflection and transmission ports of the test set are connected to the corresponding ports of the network analyzer. Port-n is any one of the test ports used to connect to the device-under-test.

7. This is crosstalk of the test set measured between the test set's interconnect ports, with shorts on the selected test ports. Crosstalk is computed by normalizing the result of an isolation measurement to a through measurement between the two ports such that the path losses are taken into account. Isolation is defined as the transmission signal measured between any two ports of the test system when these two ports are terminated with shorts.

# Test set general information

Description	Specification	Supplemental information
<b>Front panel ports</b>		
87050E, Option 004	4	Type-N, female 50Ω (nominal)
87050E, Option 008	8	Type-N, female 50Ω (nominal)
87050E, Option 012	12	Type-N, female 50Ω (nominal)
<b>Real panel</b>		
Parallel in connector	—	25-pin D-subminiature female (DB-25)
Parallel out connector	—	25-pin D-subminiature female (DB-25)
<b>Line power<sup>1</sup></b>		
Frequency 50/60 Hz	—	—
Input voltage, operating	100/120/220/240 Vac	—
Input power	—	<45 W (typical)
<b>General environment</b>		
ESD	—	Minimize using static-safe work procedures and an antistatic bench mat (Part number 9300-0797)
Dust	—	Minimize for optimum reliability
General	Indoor use only	—
Operating Temperature	0 °C to + 55 °C	—
Storage Temperature	–40 °C to + 70 °C	—
Altitude	0 to 4.5 km (15,000 ft)	—
<b>Cabinet dimensions</b>		
Height x width x depth	—	132.8 x 425 x 497 mm (nominal) 5.2 x 16.7 x 19.6 in (nominal) Cabinet dimensions exclude front and rear protrusions
<b>Weight</b>		
Net	—	8 kg (18 lb) (nominal)
Shipping	—	11 kg (24 lb) (nominal)

1. A third-wire ground is required.

# Physical dimensions

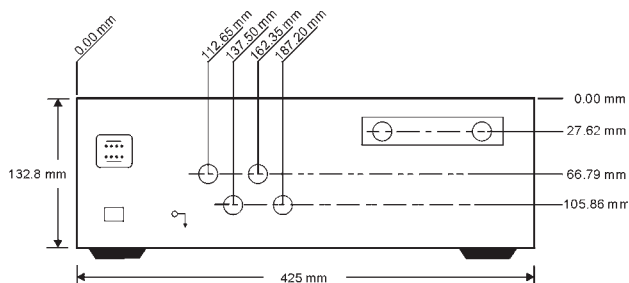

**Physical dimensions of the Agilent 87050E Option 004 multiport test set<sup>1</sup>**

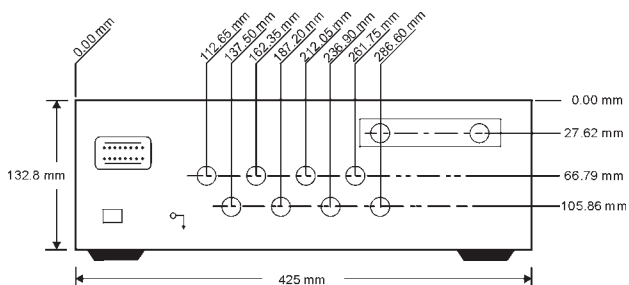

**Physical dimensions of the Agilent 87050E Option 008 multiport test set<sup>1</sup>**

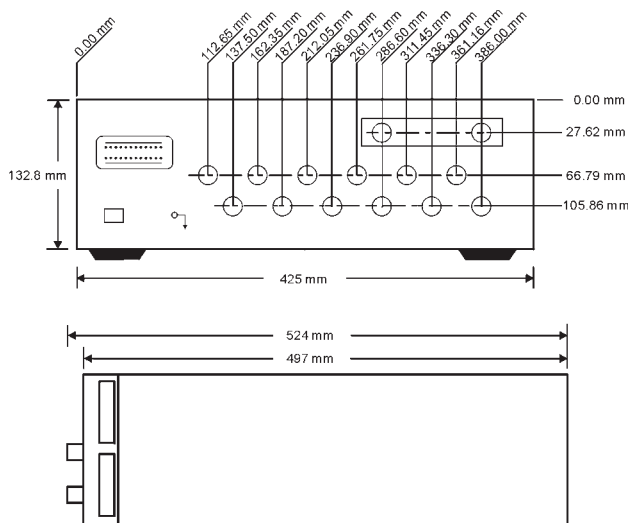

p1634e

**Physical dimensions of the Agilent 87050E Option 012 multiport test set<sup>1</sup>**

1. These dimensions exclude rear protrusions.



# Block diagrams

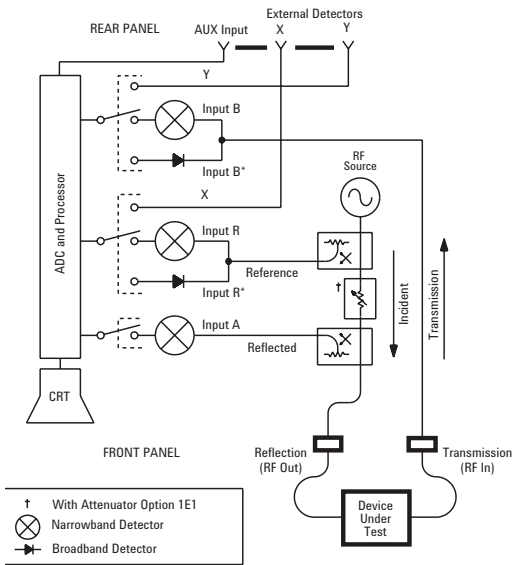

**Block diagram for the Agilent 8712ET and 8714ET**

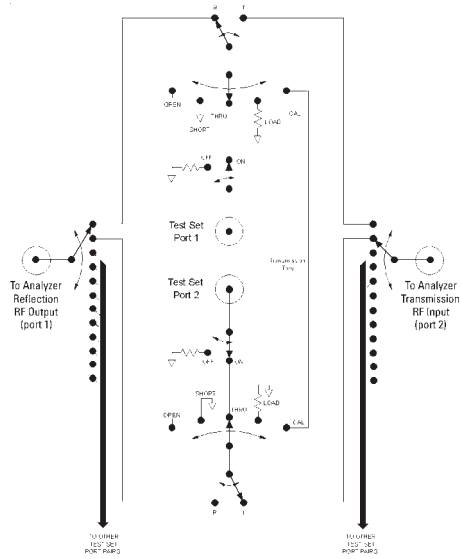

**Block diagram for the Agilent 87050E (only one test set port pair is shown)**

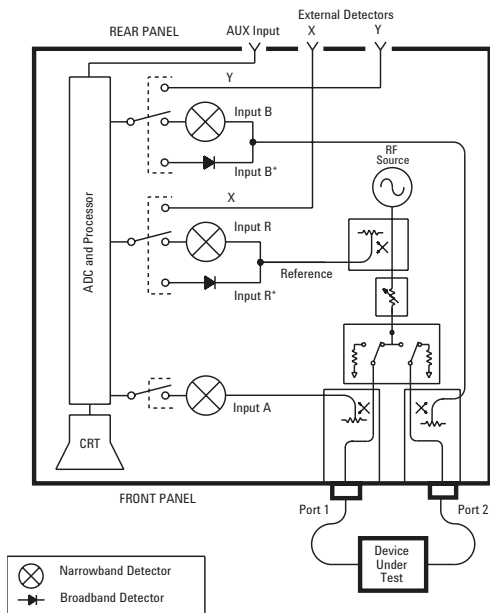

**Block diagram for the Agilent 8712ES and 8714ES**

# System features

## Test set control

Control of the switches inside the test set and calibration of the test system can be accomplished from the front panel of the network analyzer—an external computer is not required. However, the analyzers are fully programmable for use in automated test environments.

## Measurement

### Number of display measurements

Two measurement displays are available, with independent control of display parameters including format type, scale per division, reference level, reference position, and averaging. The displays can share network analyzer sweep parameters, or, by using alternate sweep, each measurement can have independent sweep parameters including frequency settings, IF bandwidth, power level, and number of trace points. The instrument can display a single measurement, or dual measurements on a split (two graticules) or overlaid (one graticule) screen.

### Measurement choices

- Narrowband  
ET models: reflection (A/R), transmission (B/R), A, B, R  
ES models:  $S_{11}$  (A/R),  $S_{22}$  (B/R),  $S_{21}$  (B/R),  $S_{12}$  (A/R), A, B, R
- Broadband  
X, Y, Y/X, X/Y, Y/R\*, power (B\*, R\*), conversion loss (B\*/R\*)

Note: X and Y denote external broadband-detector inputs; \* denotes internal broadband detectors.

### Formats

Log or linear magnitude, SWR, phase, group delay, real and imaginary, Smith chart, polar, and impedance magnitude

### Trace functions

Current data, memory data, memory with current data, division of data by memory

### Display annotations

Start/stop, center/span, or CW frequency, scale per division, reference level, marker data, softkey labels, warning and caution messages, screen titles, time and date, and pass/fail indication

## Limits

Measurement data can be compared to any combination of line or point limits for pass/fail testing. User-defined limits can also be applied to an amplitude- or frequency-reference marker. A limit-test TTL output is available on the rear panel for external control or indication. Limits are only available with rectilinear formats.

## Data markers

Each measurement channel has eight markers. Markers are coupled between channels. Any one of eight markers can be the reference marker for delta-marker operation. Annotation for up to four markers can be displayed at one time.

## Marker functions

Markers can be used in absolute or delta modes. Other marker functions include marker to center frequency, marker to reference level, marker to electrical delay, searches, tracking, and statistics. Marker searches include marker to maximum, marker to minimum, marker to target value, bandwidth, notch, multi-peak and multi-notch. The marker-tracking function enables continuous update of marker search values on each sweep. Marker statistics enable measurement of the mean, peak-to-peak and standard deviation of the data between two markers. For rapid tuning and testing of cable-TV broadband amplifiers, slope and flatness functions are also available.

## Storage

### Internal memory

1.5 Mbytes (ET models) or 1 Mbyte (ES models) of nonvolatile storage is available to store instrument states, measurement data, screen images, and IBASIC programs. Instrument states can include all control settings, limit lines, memory data, calibration coefficients, and custom display titles. If no other data files are saved in nonvolatile memory, between approximately 20 and 150 instrument states can be saved (depending on the model type and on instrument parameters). Approximately 14 Mbytes of volatile memory are also available for temporary storage of instrument states, measurement data, screen images, and IBASIC programs.

**Disk drive**

Trace data, instrument states (including calibration data), and IBASIC programs can be saved on floppy disks using the built-in 3.5 inch disk drive. All files are stored in MS-DOS®-compatible format. Instrument data can be saved in binary or ASCII format (including Touchstone/.s2p format), and screen graphics can be saved as PCX (bit-mapped), HP-GL (vector), or PCL5 (printer) files.

**NFS:** See description under Control via LAN

**Data hard copy**

Hard copy prints can be made using PCL and PCL5 printers (such as HP DeskJet or LaserJet series printers), or Epson-compatible graphics printers. Single color and multicolor formats are supported. Hard copy plots can be automatically produced with HP-GL-compatible plotters such as the Agilent 7475A, or with printers that support HP-GL. The analyzer provides Centronics (parallel), RS-232C, GPIB, and LAN interfaces.

**Automation****Controlling via GPIB Interface**

The GPIB interface operates to IEEE 488.2 and SCPI standard-interface commands.

**Control**

The analyzer can either be the system controller, or pass bus control to another active controller.

**Data transfer formats**

- ASCII
- 32- or 64-bit IEEE 754 floating-point format
- Mass-memory-transfer commands allow file transfer between external controller and analyzer.

**Control via LAN**

The built-in LAN interface and firmware support data transfer and control via direct connection to a 10 Base-T (Ethernets) network. A variety of standard protocols are supported, including TCP/IP, sockets, ftp, http, telnet, bootp, and NFS. The LAN interface is standard.

**SCPI**

The analyzer can be controlled by sending Standard Commands for Programmable Instruments (SCPI) within a telnet session or via a socket connection and TCP/IP (the default socket port is 5025). The analyzer's socket applications programming interface (API) is compatible with Berkeley sockets, Winsock and other standard socket APIs. Socket programming can be done in a variety of environments including C programs, Agilent VEE, SICL/LAN, or a Java™ applet. A standard web browser and the analyzer's built-in web page can be used to remotely enter SCPI commands via a Java applet.

**FTP**

Instrument state and data files can be transferred via ftp (file-transfer protocol). An internal, dynamic-data disk provides direct access to instrument states, screen dumps, trace data, and operating parameters.

**HTTP**

The instrument's built-in web page can be accessed with any standard web browser using http (hypertext transfer protocol) and the network analyzer's IP address. The built-in web page can be used to control the network analyzer, view screen images, download documentation, and link to other sites for firmware upgrades and VXIplug&play drivers. Some word processor and spreadsheet programs, such as Microsoft® Word 97 and Excel 97, provide methods to directly import graphics and data via a LAN connection using http and the network analyzer's IP address.

**SICL/LAN**

The analyzer's support for SICL (standard instrument control library) over the LAN provides control of the network analyzer using a variety of computing platforms, I/O interfaces, and operating systems. With SICL/LAN, the analyzer is controlled remotely over the LAN with the same methods used for a local analyzer connected directly to the computer via a GPIB interface. SICL/LAN protocol also allows the use of Agilent's free VXI plug&play driver to communicate with the multiport test system over a LAN. SICL/LAN can be used with Windows® 95/98/NT, or HP-UX.

## System features (continued)

### NFS

The analyzer's built-in NFS (network file system) client provides access to remote files and directories using the LAN. With NFS, remote files and directories (stored remotely on a computer) behave like local files and directories (stored locally within the analyzer). Test data taken by the network analyzer can be saved directly to a remote PC or UNIX® directory, eliminating the need for a remotely initiated ftp session. For Windows-based applications, third-party NFS-server software must be installed on the PC. NFS is fully supported in most versions of UNIX.

### Bootp

Bootstrap protocol (bootp) allows a network analyzer to automatically configure itself at power-on with the necessary information to operate on the network. After a bootp request is sent by the analyzer, the host server downloads an IP and gateway address, and a subnet mask. In addition, the analyzer can request an IBASIC file, which automatically executes after the transfer is complete. For Windows-based applications, third-party bootp-server software must be installed on the PC. Bootp is fully supported in most versions of UNIX.

### Programming with IBASIC

As a standard feature, all Agilent 8712ET/ES and 8714ET/ES network analyzers come with the Instrument BASIC programming language (IBASIC). IBASIC facilitates automated measurements and control of other test equipment, improving productivity. For simpler applications, you can use IBASIC as a keystroke recorder to easily automate manual measurements. Or, you can use an optional, standard PC keyboard to write custom test applications that include:

- Special softkey labels
- Tailored user prompts
- Graphical setup diagrams
- Barcode-reading capability
- Control of other test instruments via the GPIB, serial, or parallel interfaces

### Measurement calibration

Measurement calibration is a process that improves measurement accuracy by using error-correction arrays to remove systematic measurement errors.

The Test Set Cal and SelfCal features on your multiport test system increase the accuracy of your measurements and significantly increase the test efficiency of your work stations by eliminating frequent and lengthy calibration procedures.

### Test Set Cal

A Test Set Cal is a calibration that should be performed on a regular, but relatively infrequent basis (at least once a month is recommended). A Test Set Cal requires connection of mechanical calibration standards to all of the ports you will be using for your measurements.

### Test Set Cal for the Agilent 8712ET and Agilent 8714ET analyzers

The data collected by the analyzer during a Test Set Cal always includes both transmission (enhanced response) calibration data and reflection (one-port) calibration data. When making measurements after calibration, the analyzer automatically recalls and uses the correct set of calibration data for the type of measurement chosen.

### Test Set Cal for the Agilent 8712ES and 8714ES analyzers

The S-parameter network analyzers perform either two-port calibration or enhanced response/one-port calibration. Choosing a two-port calibration for the Test Set Cal removes the most systematic errors, giving you the greatest measurement accuracy. Choosing the enhanced response/one-port calibration allows faster measurement speeds, but is not as accurate as full two-port calibration.

### SelfCal

A SelfCal is an internal system calibration that automatically executes in just a few seconds on a regular, frequent basis (once per hour is recommended). A SelfCal does not require that you remove your DUT or that you make any connections of external calibration standards. The SelfCal uses the results of the most recent Test Set Cal, along with current measurements of internal, electronically switched, open, short, load and through standards. SelfCal removes the drift of the network analyzer and multiport test set due to environmental variations.

### Other calibrations

Besides using a Test Set Cal, individual instrument states and their corresponding calibrations can be saved and recalled for use with specific measurement paths. For example, to improve measurement throughput, one signal path could be tested using a response calibration, while all other paths are tested with a Test Set Cal using two-port calibration.

Note: the SelfCal feature is only supported with Test Set Cals.

A variety of calibration types are available and described below:

ES models only

- **Two-port calibration**

Compensates for frequency response, source and load match, and directivity errors while making S-parameter measurements of transmission ( $S_{21}$ ,  $S_{12}$ ) and reflection ( $S_{11}$ ,  $S_{22}$ ).

Compensates for transmission crosstalk when the **Isolation on OFF** softkey is toggled to ON. Requires short, open, load, and through standards.

### ET and ES models: transmission measurements

- **Normalization**

Provides simultaneous magnitude and phase correction of transmission frequency-response errors. Requires a through connection. Used for both narrowband and broadband detection. Does not support calibration interpolation.

- **Response**

Simultaneous magnitude and phase correction of frequency response errors for transmission measurements. Requires a through standard.

- **Response and isolation**

Compensates for frequency response and crosstalk errors. Requires a load termination on both test ports and a through standard.

- **Enhanced response**

Compensates for frequency response and source match errors. Requires short, open, load, and through standards.

### ET and ES models: reflection measurements

- **One-port calibration**

Compensates for frequency response, directivity, and source-match errors. Requires short, open, and load standards.

### Calibration kits

Data for several standard calibration kits are stored in the instrument for use by the calibration routines. They include:

- 3.5 mm (85033D)
- Type-N (85032B/E)
- 7 mm (85031B)
- 7-16 (85038A)

In addition, you can also describe the standards for a user-defined calibration kit (for example, open-circuit capacitance coefficients, offset-short length, or through-standard loss).

For more information about calibration kits available from Agilent Technologies, consult the Agilent 87050E Configuration Guide, Agilent literature number 5968-4765E.

### Key network analyzer options

#### Step attenuator (Option 1E1)

Adds a built-in 60 dB step attenuator to transmission/reflection (ET) models to extend the output power range to  $-60$  dBm. The attenuator is standard in S-parameter (ES) models.



### Agilent Email Updates

[www.agilent.com/find/emailupdates](http://www.agilent.com/find/emailupdates)

Get the latest information on the products and applications you select.

Java is a U.S. trademark of Sun Microsystems, Inc.

Microsoft, MS-DOS, Windows, Windows 95, Windows 98, Windows NT, Word 97, and Excel 97 are U.S. registered trademarks of Microsoft Corporation.

UNIX is a registered trademark of the Open Group.

## Remove all doubt

Our repair and calibration services will get your equipment back to you, performing like new, when promised. You will get full value out of your Agilent equipment through-out its lifetime. Your equipment will be serviced by Agilent-trained technicians using the latest factory calibration procedures, automated repair diagnostics and genuine parts. You will always have the utmost confidence in your measurements. For information regarding self maintenance of this product, please contact your Agilent office.

Agilent offers a wide range of additional expert test and measurement services for your equipment, including initial start-up assistance, onsite education and training, as well as design, system integration, and project management.

For more information on repair and calibration services, go to:

[www.agilent.com/find/removealldoubt](http://www.agilent.com/find/removealldoubt)

Product specifications and descriptions in this document subject to change without notice.

For more information on Agilent Technologies' products, applications or services, please contact your local Agilent office. The complete list is available at:

[www.agilent.com/find/contactus](http://www.agilent.com/find/contactus)

### Americas

Canada	(877) 894-4414
Latin America	305 269 7500
United States	(800) 829-4444

### Asia Pacific

Australia	1 800 629 485
China	800 810 0189
Hong Kong	800 938 693
India	1 800 112 929
Japan	0120 (421) 345
Korea	080 769 0800
Malaysia	1 800 888 848
Singapore	1 800 375 8100
Taiwan	0800 047 866
Thailand	1 800 226 008

### Europe & Middle East

Austria	01 36027 71571
Belgium	32 (0) 2 404 93 40
Denmark	45 70 13 15 15
Finland	358 (0) 10 855 2100
France	0825 010 700*
	*0.125 €/minute
Germany	07031 464 6333
Ireland	1890 924 204
Israel	972-3-9288-504/544
Italy	39 02 92 60 8484
Netherlands	31 (0) 20 547 2111
Spain	34 (91) 631 3300
Sweden	0200-88 22 55
Switzerland	0800 80 53 53
United Kingdom	44 (0) 118 9276201

Other European Countries:

[www.agilent.com/find/contactus](http://www.agilent.com/find/contactus)

Revised: March 24, 2009

© Agilent Technologies, Inc. 2009  
Printed in USA, April 15, 2009  
5968-4764E

